



TRIOPTICS

TRIOPTICS GMBH · OPTISCHE INSTRUMENTE

OptiTest®

a complete range
of Optical Instruments



DESCRIPTION	Page
• OPTITEST - a modular Optical Test Equipment2
• Collimators3
• Telescopes4
• Autocollimators7
APPLICATIONS	
• Collimators and Telescopes5
• Autocollimators9
INSTRUMENTS	
• Collimators14
• Focusing Collimators15
• Telescopes16
• Focusing Telescopes17
• Autocollimators18
• Autocollimators with Eyepiece Micrometers20
• Focusing Autocollimators21
• Focusing Autocollimators with Eyepiece Micrometers22
• Large Field Autocollimators22
• LED-Autocollimators23
• Diopter Telescopes24
• Dynameter25
• Square Body Telescopes and Collimators26
COMPONENTS & ACCESSORIES	
• Tube Mounted Objective Lenses27
• Objective Tube Accessories29
• Achromats in Mount	
Dual Adapter	
Micro-Objectives	
Laser Alignment Attachment	
• Reticle Adapters and Autocollimation Heads33
• Eyepieces and Illuminations35
• Reticles38
• Positioning Equipment44
Holders	
Tables	
Stands	

OPTITEST

A COMPREHENSIVE AND MODULAR OPTICAL TEST EQUIPMENT.

The optical testing usually requires a wide range of configurations specific to the application or the parameters to be measured. The large variety of the set-ups is, however, a combination of basic optical instruments known as:

- collimators
- telescopes
- autocollimators
- achromats
- mechanical hardware for positioning of the basic optical instruments



The OPTITEST is a comprehensive line of equipment including the largest range of basic optical instruments and additional mechanical hardware. To cover all conceivable testing set-ups required by fast changing applications, the components of OPTITEST line are design as a modular system.

The OPTITEST components are interchangeable and compatible with each other. This [modular approach](#) and the extensive range of instruments

belonging to OPTITEST result in significant advantages for the user:

- unlimited flexibility to set up systems to cover present and future applications
- a cost effective solution since the basic components are identical in any configuration
- user freedom to set up the required equipment by himself since everything is already factory adjusted



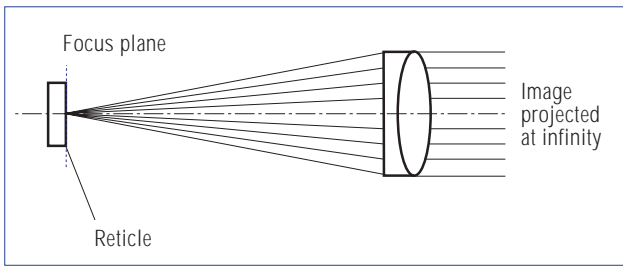

Standard Collimator
Infinity setting

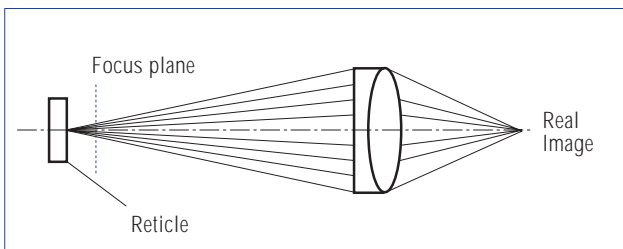

Focusing Collimator
Finite distance setting-Real image

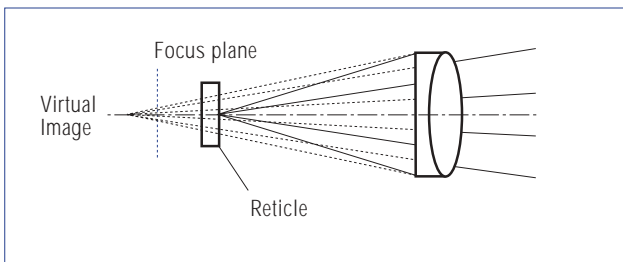

Focusing Collimator
Finite distance setting-Virtual image

COLLIMATORS

TERMS AND DEFINITIONS

The Collimator is an optical instrument consisting of a well corrected objective lens with an illuminated reticle at its focal plane. The emerging beam is parallel (collimated beam), so that the image of the reticle is projected at infinity. The collimator is usually set up in this way known as **infinity adjustment** (setting).

When moving the reticle out of the focal plane of the objective lens, the shape of the emerging beam will change:

- Moving the reticle away from objective lens will result in a convergent beam. The image of the reticle is real and projected at a **finite distance**.

- Moving the reticle toward the objective lens will result in a divergent beam. If the beam diverges, a virtual image is produced at the apparent crossing point of the beam rays. This point is also located at a finite distance. This adjustment of the collimator is known as **finite distance setting**.



CONSTRUCTION

The main components of a standard collimator (infinity setting) are:

- Tube mounted objective lens
- Reticle adapter
- Illumination device

A focusing collimator (finite distance setting) is similar built, however, the reticle adapter is mounted on a draw out tube for focusing adjustment.

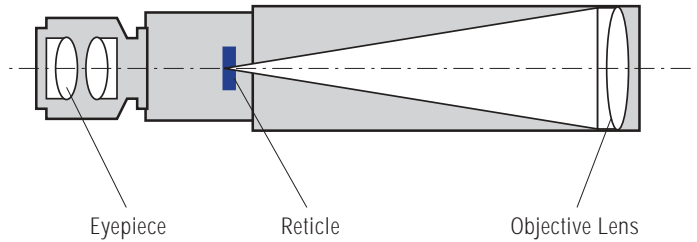
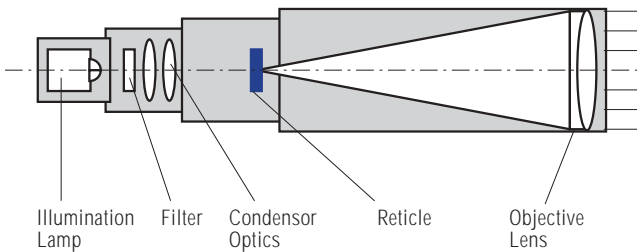

When the incoming beam is parallel, the image observed through the telescope is located at infinity i.e at a long distance. This set up in is known as **infinity setting**.

Similar to collimators, the telescopes can be focused at finite distances. Attaching a draw out tube to the reticle adapter to move the reticle out of the focal of the objective lens, the standard telescope becomes a focusing telescope. Depending on the location of the reticle relatively to the focal plane, it results a real or a virtual image at a **finite distance**.

TELESCOPES

TERMS AND DEFINITIONS

The telescope is a sighting device usually with a magnification greater than unity used for image enlargement or measurement purposes. It consists of a well corrected objective lens, a reticle at its focal plane and an eyepiece.

CONSTRUCTION

The main components of a standard telescope (infinity setting) are:

- Tube mounted objective lens
- Reticle adapter
- Eyepiece

A focusing telescope (finite distance setting) is similar built, however, the reticle adapter is mounted on a draw out tube for focusing adjustment.



COLLIMATORS AND TELESCOPES

OPERATING PRINCIPLE AND APPLICATIONS

In the optical metrology the collimators and telescopes are mostly used together to measure different optical and geometrical parameters:

ANGLE MEASUREMENT

A telescope mounted in the front of a collimator enables the simultaneous observation of both collimator and telescope reticle. When a collimator is perfectly aligned to a telescope the reticles are superimposed and no displacement occurs.

The presence of an angle „α“ between the the collimator and telescope axes is shown by a linear displacement „d“ between the two reticles. The displacement „d“ gives the size of the angular disalignment (in radians) of the two instruments:

$$\alpha = \frac{d}{f}$$

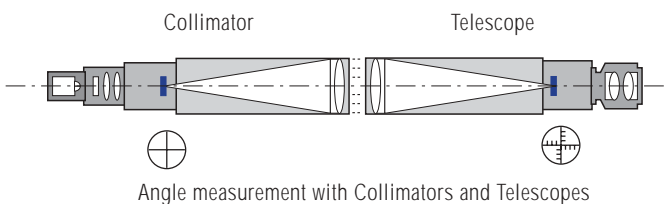

where:

d=linear displacement measured in the reticle plane (focal plane)

f=effective focal length (EFL) of the observing instrument (i.e.telescope)

To ease the angular alignment of equipment with flat surfaces a special type of instruments can be used: the square body collimators and telescopes. The reticles of these instruments are accurately aligned to the outer square body surfaces.

 **TRIOPTICS Square Body Collimators and Telescopes**

Since collimators and telescopes used for angle measurement have a standard infinity setting and therefore the beams of the instruments are parallel, the measurement is not affected:

- when a parallel displacement of the optical axes occurs
- when the distance between the instrument is modified

Typical applications related to angle measurement:

Measurement of the transmission angle through prisms

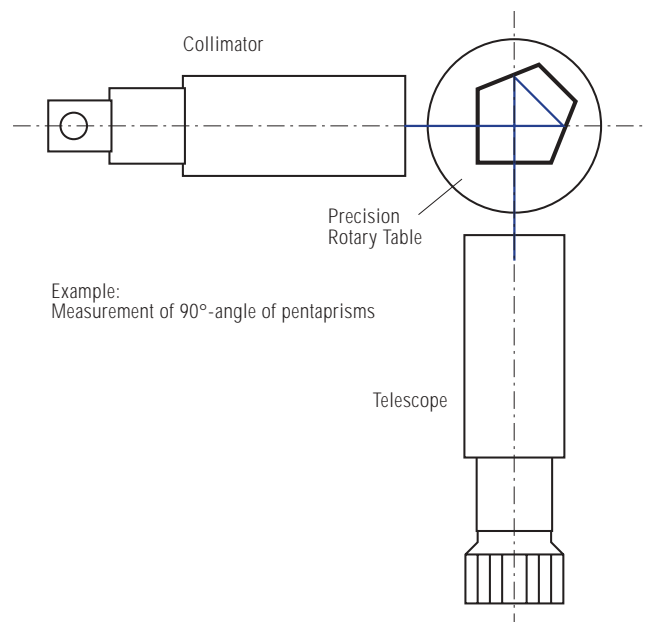

- absolute measurement: The telescope is attached to a precision rotary table with read out:
First reading: collimator and telescope aligned (without sample)
Second reading: sample positioned, telescope rotated until the reticles are superimposed. Reading on rotary table.
- relative measurement: a master prism is used, collimator and telescope rotated until reticles are superimposed and fixed in this position. The sample is placed instead of master prism. Reading on telescope.

 **TRIOPTICS Goniometer**

Alignment of prism systems

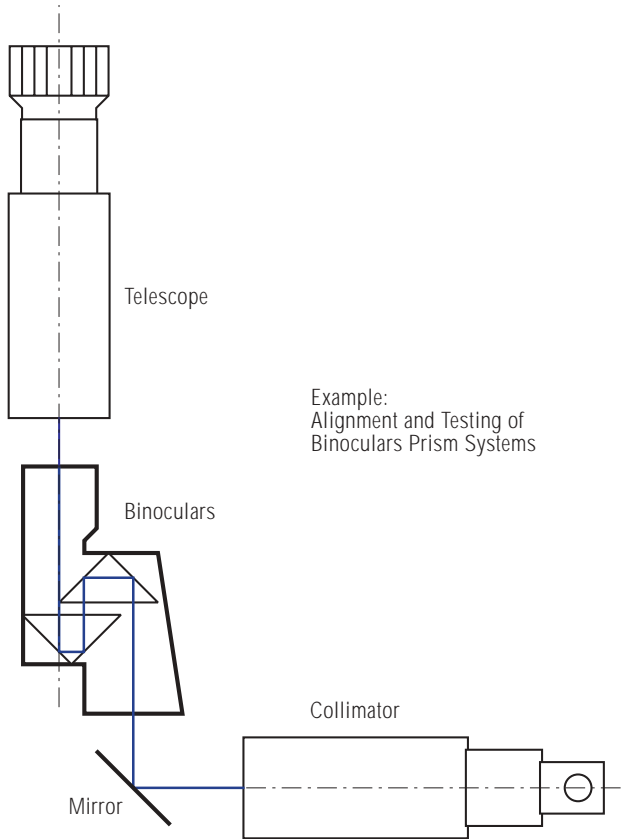

The collimator and the telescope is strictly aligned. When the binoculars or the prism system only are placed between the collimator and telescope tilt and rotation of prisms can be measured.

 **TRIOPTICS Binoculars Testing Instrument**

TESTING IMAGE QUALITY

The collimators used for testing the image quality are equipped with reticle containing a resolution pattern (chart) as USAF resolution target, Siemens Star, Foucault Test etc. The telescope or any other sighting devices are pointed to the testing collimator. The limiting number of lines per millimeter that a sighting device is capable to resolve on the collimator reticle is determining the resolution or image quality.

Another typical set up for testing image quality of lenses consists of a collimator which projects a resolution target to the lens under test. The

image of the resolution target formed in the focal plane of the sample is observed through a microscope.

 **TRIOPTICS Master Collimator**
 **TRIOPTICS Optical Bench**

MEASUREMENT OF OPTICAL PARAMETER

Measurement of focal length

A typical application is the measurement of the effective focal length EFL. A highly corrected collimator set to infinity (emerging beam is parallel) has a reticle with a pair of spaced lines located in its focal plane. The image of the reticle is projected over the lens under test and focused in its focal plane. By means of a

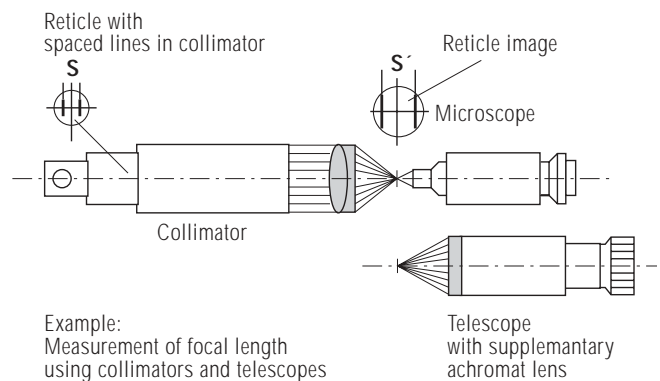

microscope (or a telescope with a supplementary achromat) the size of spaced lines is determined and the EFL calculated:

$$f = f_{col} \cdot \frac{S'}{S}$$

 **TRIOPTICS Optomatic**
 **TRIOPTICS OptiAngle**

Measurement of centration errors

A collimator set to infinity contains a reticle with a dark or bright cross. The lens under test is placed in a precision rotary holder. The image of a reticle projected over the lens under test is observed by means of a telescope with additional achromat having a graduated reticle.

While rotating the holder with the lens, the cir-

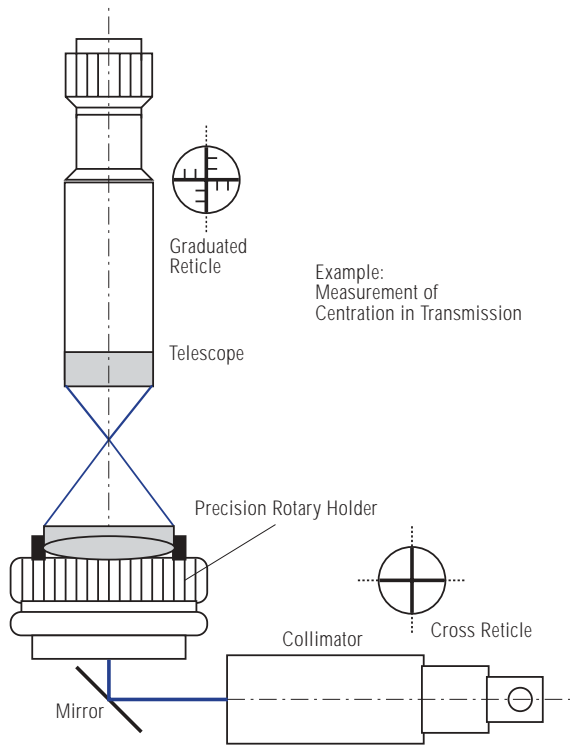

cle described by the reticle image is measured.

-  [TRIOPTICS OptiAngle](#)
-  [TRIOPTICS Ultra-Precision Rotary Holders](#)

MEASUREMENT OF THE FOCUSING DISTANCES

Many telescopes and sighting devices are designed to be focused at different distances over a given range. To measure the distance setting of sighting devices a focusing collimator with a accurately graduated draw out tube is focused at the distance to be checked. Through the eyepiece of the sighting device the collimator reticle is observed. If the image of the collimator reticle appears sharp within the required tolerance, the sighting device is correctly adjusted. Deviations are measured and read off on the graduated draw out tube of the collimator.

TERMS AND DEFINITIONS

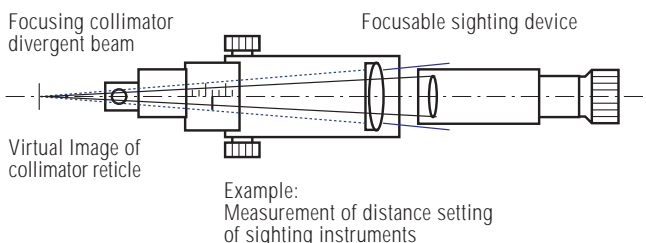

AUTOCOLLIMATORS

The Autocollimator is a single instrument combining the functions of a collimator and a telescope. It detects small angular displacements of a mirror by means of its own collimated light.

The two reticles are positioned in the focal plane of the corrected objective lens, so that the emerging beam is parallel. This usual configuration is known as **infinity setting**, i.e. the autocollimators are focused at infinity.

When moving the reticles out of the focal plane of the objective lens, the autocollimator can be focused at **finite distances**, and the beam becomes divergent (producing a virtual image) or convergent (real image). This results in a focusing autocollimator. The shape of the beam -convergent or divergent-depend on the direction in which the reticles are moved.

CONSTRUCTION

The main components of a standard autocollimator i.e. focused at infinity are:

- Tube mounted objective lens
- Beam splitter mount which contains two reticles
- Eyepiece
- Illumination device

The illuminated reticle projected over the beamsplitter towards the lens is known as **collimator reticle**. The second reticle placed in the focus of the eyepiece is the **eyepiece reticle**. The beamsplitter mount together with the eyepiece and the illumination device form a main

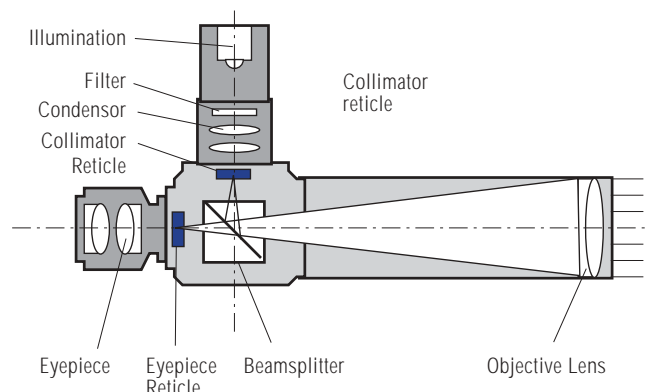

unit called: **Autocollimator Head**.

A focusing autocollimator (finite distance setting) is similarly built. The autocollimator head containing the two reticles is now mounted on a draw out tube for focusing adjustment.

OPERATING PRINCIPLE

Autocollimation is an optical technique of projecting an illuminated reticle to infinity and re-

posed-no displacement occurs.

If the reflector is tilted by an angle α , the reflected beam is deflected by twice that angle i.e. 2α . The reflected image is now laterally displaced with respect to the eyepiece reticle. The amount of this displacement „d“ is a function of the focal length of the autocollimator and the tilt angle of the reflector: $d=2\alpha f$. (α in radians). The tilt angle can be ascertained with the formula: where „f“ is the effective focal



ceiving the reticle image after reflection on a flat mirror. The reflected image is brought to the focus of the objective lens in which the eyepiece reticle is located. Thus the reflected image of the collimator (illuminated) reticle and the eyepiece reticle can be simultaneously observed. When the collimated beam falls on a mirror which is perpendicular to beam axis, the light is reflected along the same path. Between the reflected image and the eyepiece reticle -which are seen superim-

length EFL of the autocollimator. Since the „f“ is a constant of the autocollimator, the eye-

$$\alpha = \frac{d}{2f}$$

piece reticle can be graduated in angle units and the tilt angle can be directly read off.

APPLICATIONS

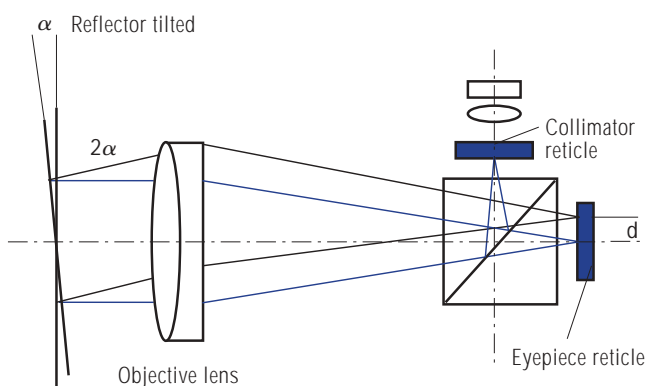

The applications of autocollimators are mainly related to detection and measurement of small angular displacements:

ANGLE MEASUREMENT OF OPTICAL COMPONENTS

Measurement of wedge and deflection angle

The parallel beam emerging from autocollima-

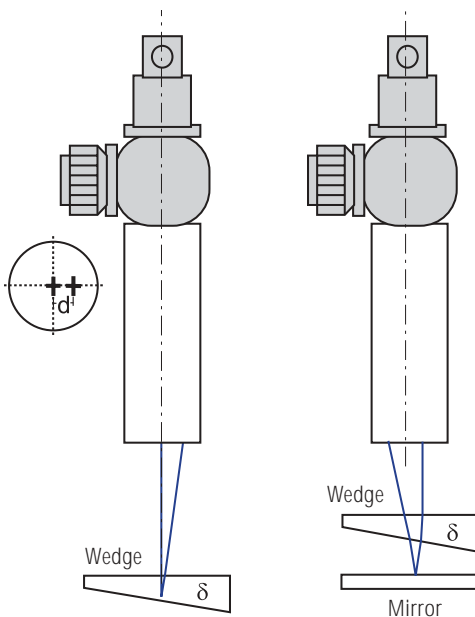

Measurement of wedge and deviation angle with Autocollimators

tor is reflected from both surfaces of the wedge. The **wedge angle** δ is given by:

where:

$$\delta = \frac{d}{2nf}$$

d-displacement of the reflected image
 n-refractive index of glass
 f-focal length of the autocollimator

For fast measurement in optical manufacturing, the displacement „d“ for a given angle tolerance and focal length „f“ can be calculated and transferred to the illuminated reticle in form of a pinhole, so that the ascertainment of the component can be made on a „go“ and „no go“ basis:

- A)-Wedge out of tolerance
- B)-Wedge at the tolerance limit
- C)-Wedge in tolerance

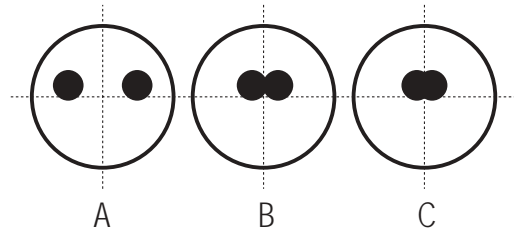

The **deflection angle** through the wedge γ is given for small angles by:

$$\gamma = \frac{d(n-1)}{2nf}$$

- TRIOPTICS Optiangle
- TRIOPTICS Autocollimators with pinhole reticles

Measurement of prisms angles

The range of applications in this field is very wide, only some fundamental set ups are presented:

Internal angle of 90° prisms

The reflected images from the 90° sides (which are insensitive against rotation around the roof edge) are displaced by an amount „x“, if a deviation from 90° angle „ α “ is present.

A presence of a displacement in height by the amount „y“ proves a pyramid error „ γ “ as well:
 n-refractive index of glass
 f-focal length of the auto-

$$\alpha = \frac{x}{4nf} \quad \gamma = \frac{y}{4nf}$$

collimator
90°-Angle of Prisms

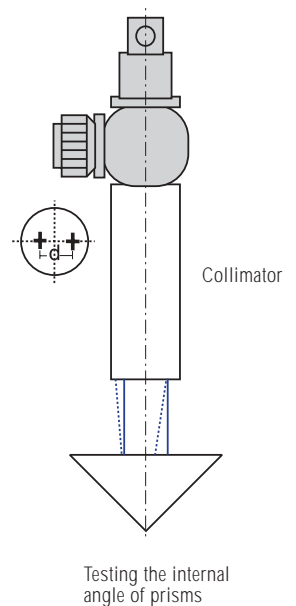

Testing the internal angle of prisms

The 90° prism is put on an accurate flat surface. The emerging beam of autocollimator is reflected on the prism side and flat and returns along the original path if the angle is exactly 90°. No displacement appears in the eyepiece. Deviations from 90° can be measured in the eyepiece. The error size:

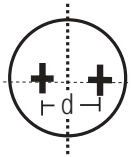

$$\alpha = \frac{d}{4f}$$

where f = focal length of

autocollimator. The sign -/+ of the error is determined by defocusing the eyepiece: moving the focal plane of the eyepiece towards ob-

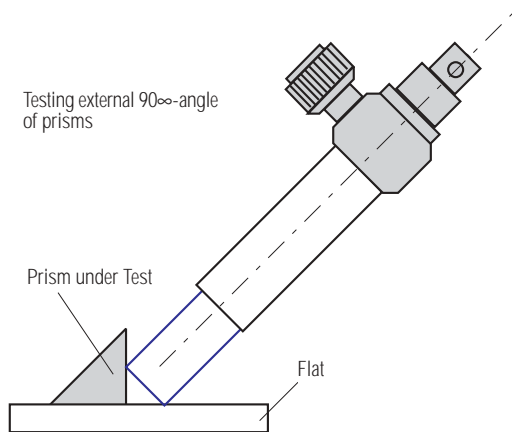

jective lens, a negative error results if the distance „d” becomes smaller.

45° Angle of Prisms

a) Relative measurement of 45°-angle

To measure the 45° angle a master prism is used. Both prisms are put on an accurate flat. The 90° angle of the prism under test must be checked first, since the error of this angle will influence the measurement.

b) Absolute mea-

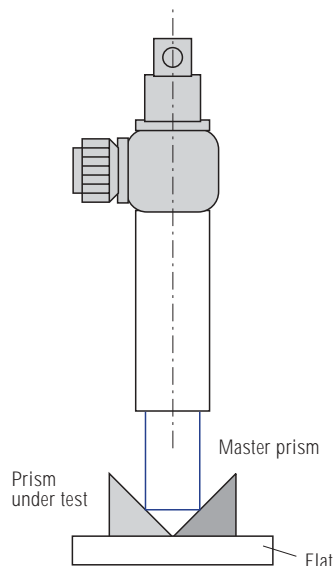

surement of 45°-angle

The Autocollimator is directed on one side of the 90°-angle. Two images will be produced from both sides of the prism.

The internal reflection within the prism will produce a displacement „d” depending on the error of the 45° angle „α”:

$$\alpha = \frac{d}{4nf} \pm \frac{\delta}{2}$$

where δ is the error of 90° angle.

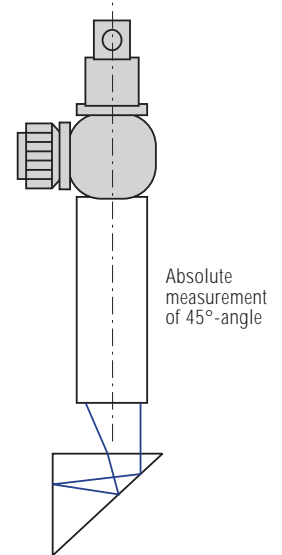

Measurement of deviation angle through prisms

The autocollimator is mounted on an adjustable stand and can be tilted at any angle. A master prism is used to align the autocollimator to the mirror. The master prism is replaced by the prism under test and the angle difference is read off through the eyepiece.

Example: Measurement of deviation angle through pentaprisms.

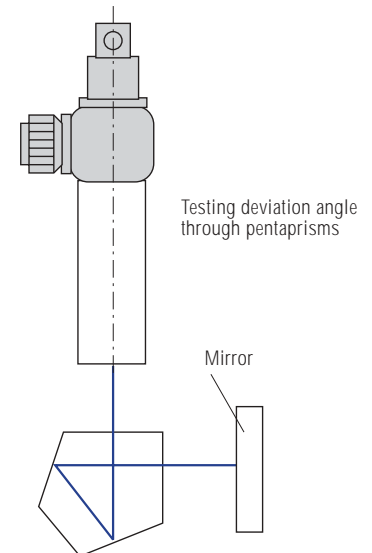

CHECKING THE STRAIGHTNESS, SQUARENESS, PARALLELISM AND FLATNESS

The measurement of geometrical parameters of mechanical parts is a typical application in machine construction, machine tools and aerospace industry.

Straightness Measurement

A mirror is either moved along the surface or mounted on a movable part of the machine to be measured. The mirror is supported by balls or pins placed at a distance „b“ known as „base length“. Deviations from straightness will result in tilt of the mirror. Deviation from straightness are given by:

$$h = \tan \alpha b$$

where:

α = mirror tilt

b = base length

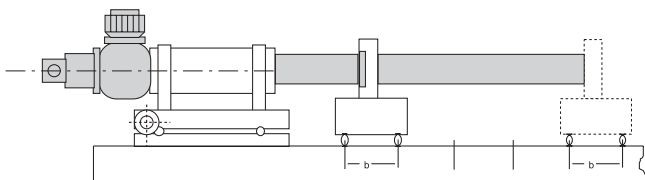

Straightness Measurement with Autocollimators and Mirrors

When computerised or electronic autocollimators are used, readings can be automatically entered into computer. The software program permits straightness measurement on machine tool slideways, shafting, stages, rolls etc.

Flatness Measurement

The „base mirror“ is moved along diagonals and rectangles of the surface to be measured. Along each line a straightness measurement is carried out. The data from surface generators lines are used to calculate the shape of the surface and the deviations from flatness.

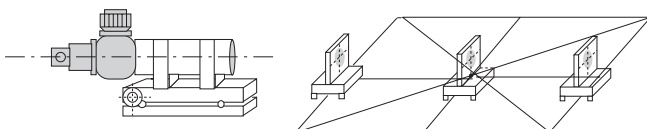

The data can be entered into a computer to produce a topography of the surface under test.

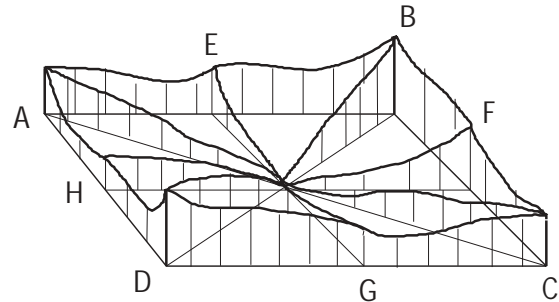

Topography of a surface measured with Autocollimators

Squareness Measurement

The procedure is similar with straightness measurement. The measurement of the first surface is made in the same way. Further an accurate pentaprism is used to transfer the autocollimator beam to the second surface. The straightness of the second surface is measured. The data are then combined and corrected for the error of the pentaprism.

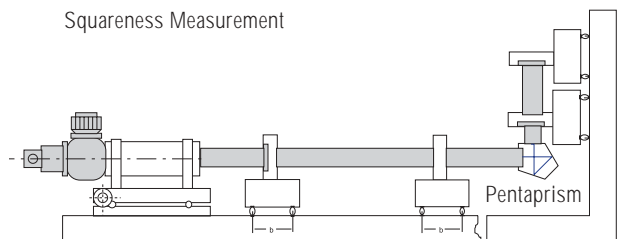

Squareness Measurement

CALIBRATION OF ROTARY TABLES

A reflecting polygon is put on rotary table or dividing head under test. One side of the polygon is squared to the optical axis of the autocollimator. The rotary table is set on zero. The rotary table with the polygon is rotated until next polygon side is square to autocollimator. The graduation of the table is compared with the expected angle.

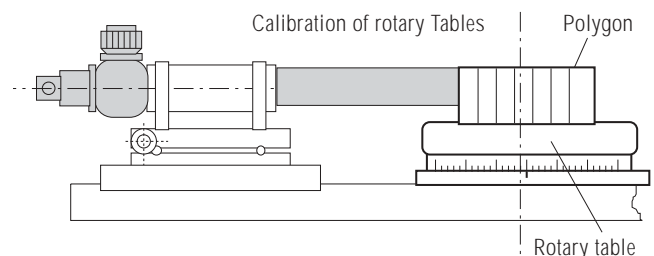

Measurement of parallelism

The reference surface is aligned to the autocollimator. The autocollimator is fixed in this position. The mirror is transferred to next surface which is aligned to the same autocollimator:

Example: Parallel alignment of bearings

After the first bearing is squared to autocolli-

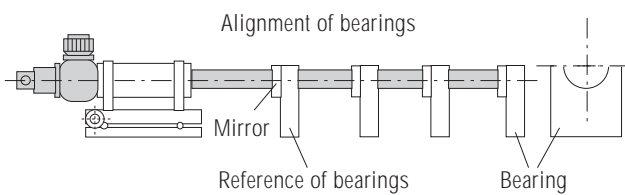

mator, the mirror is transferred to the next bearing. Deviation from parallelism is read off and the bearing aligned.

Example: Parallel alignment of rolls.

A mirror mounted on a V-block is put on the first (reference) rolls. After adjustment, the mir-

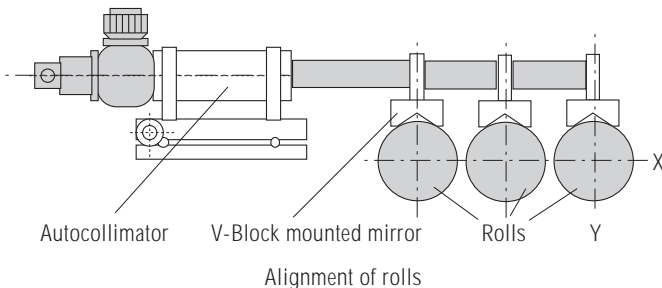

ror is square to autocollimator. The reference roll is now aligned along X-axis of the autocollimator. The mirror is transferred to the next rolls and the procedure repeated. Two spirit levels mounted on the V-block can be used for levelling the rolls.

MEASUREMENT OF OPTICAL PARAMETERS

Radius of curvature

Additional achromats are mounted on the one end of the autocollimator tube. The illuminated image of the autocollimator will be projected into the focal plane of the achromat. This image is reflected back from the vertex of the lens and the center of curvature of lens surface. The linear displacement between these two positions - where a sharp image is seen in

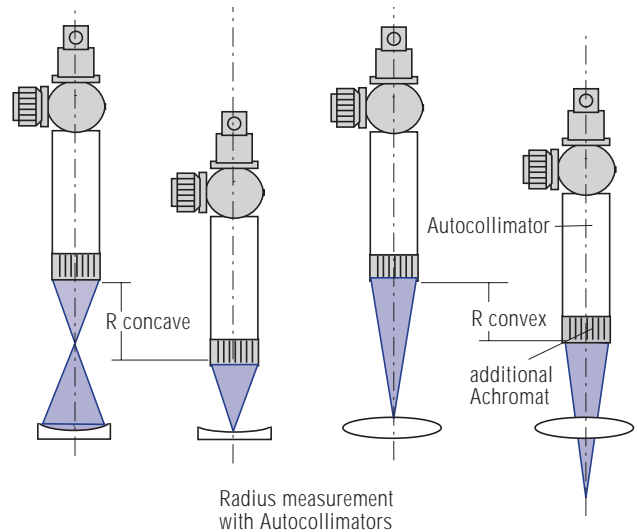

the eyepiece - gives the radius of curvature. Both concave and convex surfaces can be measured. Spherical and cylindric surfaces can be measured as well. For convex surfaces the back focal length of the achromat must be longer than the radius under test.

For measurement of very long radii of curvature focusing autocollimators with draw out tubes can be used. Drawing out the tube with the autocollimation head, the autocollimator can be focused on the lens vertex and centre of curvature. Since the nearest focus point for a focusing autocollimator is in a distance of some meters and the focusing on the vertex is practically difficult, following configuration is recommended:

The lens under test is positioned with the vertex at a distance „f“ from autocollimator lens.

(f-effective focal length EFL of the autocollimator).

After focusing in the centre of curvature of the lens, the radius is given by:

$$R = \frac{f^2}{d}$$

where d=displacement of the draw out tube read off on its scale

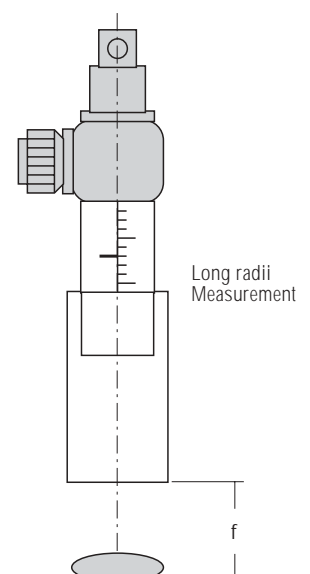

Measurement and Testing of Flange Focus

The Flange Focus known also as Flange Focal Length (FFL) or Flange Focal Distance (FFD) is the distance between the locating surface of the lens mount and the image plane. Checking and setting of this distance is important especially for camera lenses. The film plane is replaced by a mirror mounted on an adjustable jig.

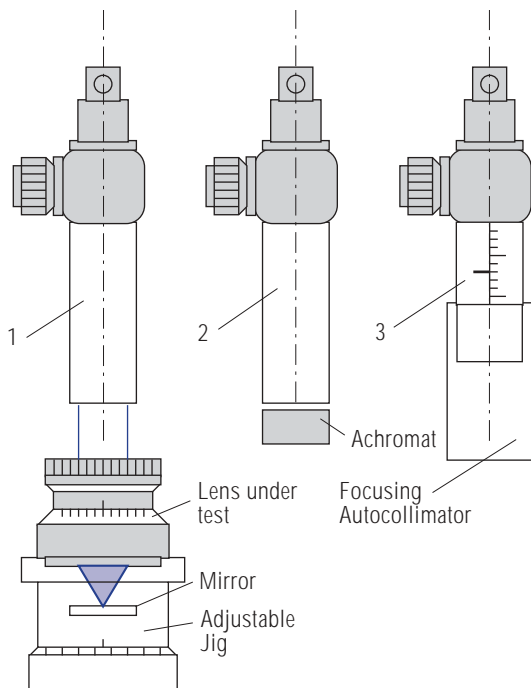

Testing Flange Focal Distance

For checking the FFD when the lens under test is set to infinity a standard autocollimator (1) is used. For testing the lens set at other distances as infinity is recommended:

- achromats attached to the autocollimator for short distances (2)
- a focusing autocollimator for infinity and long distances (3)

The reticle normally used is a Siemens Star. When the reticle is sharply seen at the given distance, the camera lens is correctly set. Deviations can be measured with an adjustable jig and the lens correspondingly adjusted.

Measurement of Centration errors



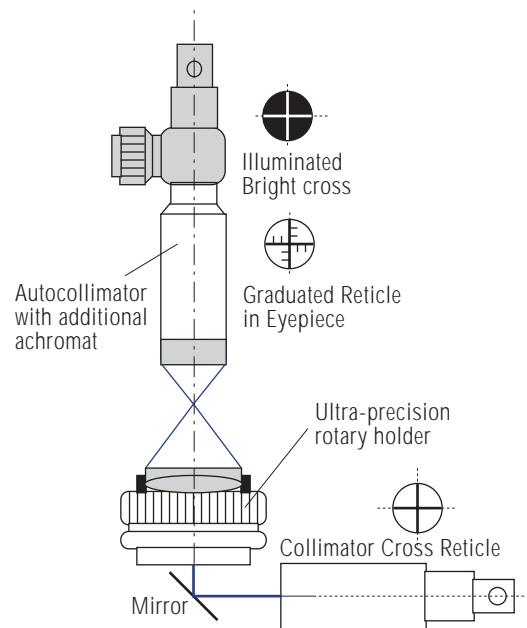





The autocollimators can be used for measurement of centration errors in **transmission** (see collimators applications) or in **reflection**: For measurement in reflection additional achromats are attached to autocollimator. The precision rotary holder is equipped with a chuck running true to the rotation axis. The spherical surface under test is located on the front surface of the chuck and held in contact by means of a small vacuum device. When rotated, the surface under test will reflect the image reticle. This image describes a circle with a diameter depending on the decentration size.



Measuring Centration in Transmission

- [TRIOPTICS Precision Rotary Holders](#)
- [TRIOPTICS OptiAngle](#)

COLLIMATORS







Type	Code	Focal length (mm)	Tube diameter (mm)	Free Aperture (mm)	Field of View	Reticle Adapter
COL 100-38	3-100-001	100	38,1	30	6°	
COL 150-38	3-100-002	150	38,1	30	4°	
COL 200-38	3-100-003	200	38,1	30	3°	
COL 300-38	3-100-004					
COL 300-38 RC	3-100-014	300	38,1	30	2°	
COL 300-38 RC/FC	3-100-114					
COL 300-57	3-100-005					
COL 300-57 RC	3-100-015	300	57	50	2°	
COL 300-57 RC/FC	3-100-115					



COLLIMATORS













STANDARD COLLIMATORS (CONTINUED)

Infinity Setting

Type	Code	Focal length (mm)	Tube diameter (mm)	Free Aperture (mm)	Field of View	Reticle Adapter
COL 500-57	3-100-006	500	57	50	1,2°	
COL 500-57 RC	3-100-016					
COL 500-57 RC/FC	3-100-116					
COL 1000-115	3-100-008	1000	115	100	0,6°	
COL 1000-115 RC	3-100-018					
COL 1000-115 RC/FC	3-100-118					

FOCUSING COLLIMATORS

Finite Distance Setting

Type	Code	Focal length (mm)	Tube diameter (mm)	Free Aperture (mm)	Field of View	Focusing range	Reticle Adapter
COL F300-38±25	3-101-004	300	38,1	30	2°	∞ to ±3,6 m	
COL F300-38±25 RC	3-101-014						
COL F300-38±25 RC/FC	3-101-114						
COL F300-57±25	3-101-005	300	57	50	2°	∞ to ±3,6 m	
COL F300-57±25 RC	3-101-015						
COL F300-57±25 RC/FC	3-101-115						
COL F500-57±50	3-101-006	500	57	50	1,2°	∞ to ±5 m	
COL F500-57±50 RC	3-101-016						
COL F500-57±50 RC/FC	3-101-116						
COL F1000-115±50	3-101-008	1000	115	100	0,6°	∞ to ±20 m	
COL F1000-115±50 RC	3-101-018						
COL F1000-115±50	3-101-118						

Delivery Kit

The Collimators are delivered as complete - ready to work-instruments:

- tube mounted objective lens
- reticle adapter incl. reticle
- illumination with green filter and 5W/6V bulb

The reticle adapters which might be included are:



Standard reticle adapter including one reticle at choice



RC-Reticle changer with 4 positions. Four reticles at choice are included.

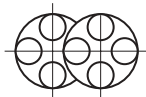

RC/FC-Reticle changer with 4 positions. Four reticle at choice are included. Filter changer with 4 positions. One green and one white difuser are included. Further filters on request.

Optional Items

- Power supply (Transformer) for illumination
- Holders
- Other illumination devices (cold light source 150W, halogene illumination 20W)

Ordering Information

To order a collimator please specify:

3-101-114 COL F 300 -38 ±25 RC/FC RET-XX

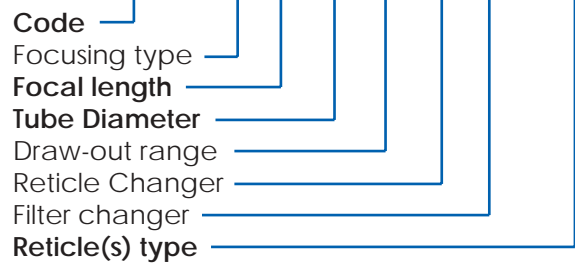

TELESCOPES

PRODUCT RANGE AND SPECIFICATION

STANDARD TELESCOPES

Infinity Setting

Type	Code	Focal length (mm)	Tube diameter (mm)	Free Aperture (mm)	Field of View	Resolution for reticle line width 10 µm
TEL 100-38 TEL 100-38 R	3-100-021 3-100-031	100	38,1	30	6°	20 arcsec
TEL 150-38 TEL 150-38 R	3-100-022 3-100-032	150	38,1	30	4°	14 arcsec
TEL 200-38 TEL 200-38 R	3-100-023 3-100-033	200	38,1	30	3°	10 arcsec
TEL 300-38 TEL 300-38 R	3-100-024 3-100-034	300	38,1	30	2°	7 arcsec
TEL 300-57 TEL 300-57 R	3-100-025 3-100-035	300	57	50	2°	7 arcsec
TEL 500-57 TEL 500-57 R	3-100-026 3-100-036	500	57	50	1,2°	4 arcsec
TEL 1000-115 TEL 1000-115 R	3-100-028 3-100-038	1000	115	100	0,6°	2 arcsec



FOCUSING TELESCOPES

Finite Distance Setting

Type	Code	Focal length (mm)	Tube diameter (mm)	Free Aperture (mm)	Field of View	Resolution for reticle line width 10 µm	Focusing range
TEL F300-38±25 TEL F300-38±25 R	3-101-024 3-101-034	300	38,1	30	2°	7 arcsec	∞ to±3,6 m
TEL F300-57±25 TEL F300-57±25 R	3-101-025 3-101-035	300	57	50	2°	7 arcsec	∞ to±3,6 m
TEL F500-57±50 TEL F500-57±50 R	3-101-026 3-101-036	500	57	50	1,2°	4 arcsec	∞ to±5 m
TEL F1000-115±50 TEL F1000-115±50	3-101-028 3-101-038	1000	115	100	0,6°	2 arcsec	∞ to±20 m

Delivery Kit

The Telescopes designated by the code mentioned in the table are delivered as complete -ready to work-instruments:

- tube mounted objective lens
- reticle adapter incl. reticle
- standard eyepiece, magnification 16x

Optional Items

- Eyepieces with magnification 10x, 12x and 25x
- Holders
- Eyepiece micrometers

- Additional achromats in mount fitting on the objective lens tube
- CCD-camera attachment

Ordering Information

To order a telescope please specify:

3-100-036 TEL 500 -57 R (EPC25) RET-XX

Code
 Focal length
 Tube Diameter
 Right angle viewing
 Non standard eyepiece
 Reticle(s) type















AUTOCOLLIMATORS

PRODUCT RANGE AND SPECIFICATION



STANDARD AUTOCOLLIMATORS

Infinity Setting

Type	Code	Focal length (mm)	Tube diameter (mm)	Free Aperture (mm)	Field of View/ Measuring Range	Resolution for reticle line width 10 μ	Beam Splitter in Mount with reticles
ACM 100-38	3-100-061	100	38,1	30	6°/3°	10 arcsec	
ACM 150-38	3-100-062	150	38,1	30	4°/2°	7 arcsec	
ACM 200-38	3-100-063	200	38,1	30	3°/1,5°	5 arcsec	
ACM 300-38	3-100-064						
ACM 300-38 RC	3-100-094	300	38,1	30	2°/1°	3,5 arcsec	
ACM 300-38 RC/FC	3-100-194						
ACM 300-57	3-100-065						
ACM 300-57 RC	3-100-095	300	57	50	2°/1°	3,5 arcsec	
ACM 300-57 RC/FC	3-100-195						
ACM 500-57	3-100-066						
ACM 500-57 RC	3-100-096	500	57	50	1,2°/0,6°	2 arcsec	
ACM 500-57 RC/FC	3-100-196						
ACM 1000-115	3-100-068						
ACM 1000-115 RC	3-100-098	1000	115	100	0,6°/0,3°	1 arcsec	
ACM 1000-115RC/FC	3-100-198						



Autocollimator with Reticle Changer (RC) and Filter Changer (FC)

The reticle and filter changer feature 4 locations for reticles and filters respectively

AUTOCOLLIMATORS
 WITH EYEPIECE MICROMETERS
 Infinity Setting













Type	Code	Focal length (mm)	Tube diameter (mm)	Free Aperture (mm)	Measuring range / Micrometer range	Resolution for Micro/Digi (arcsec)
ACM 200-38 Micro	3-100-073	200	38,1	30	1,5°/0,6°	2,5
ACM 300-38 Micro ACM 300-38 Digi	3-100-074 3-100-084	300	38,1	30	1°/0,4°	1,7/ 0,35
ACM 300-57 Micro ACM 300-57 Digi	3-100-075 3-100-085	300	57	50	1°/0,4°	1,7/ 0,35
ACM 500-57 Micro ACM 500-57 Digi	3-100-076 3-100-086	500	57	50	0,6°/0,23°	1/ 0,2
ACM 1000-115 Micro ACM 1000-115 Digi	3-100-078 3-100-088	1000	115	100	0,3°/0,11°	0,5/ 0,1

 Autocollimator with eyepiece micrometer
 Micro-Mechanical Micrometer Digi-Digital Micrometer

AUTOCOLLIMATORS

FOCUSING AUTOCOLLIMATORS

Finite Distance Setting

Type	Code	Focal length (mm)	Tube diameter (mm)	Free Aperture (mm)	Field of View/ Measuring Range	Focusing Range	Beam Splitter in Mount with reticles
ACM F 300-38±25	3-101-064						
ACM F 300-38±25 RC	3-101-094	300	38,1	30	2°/1°	∞ to ±3,6m	
ACM F 300-38±25 RC/FC	3-101-194						
ACM F 300-57±25	3-101-065						
ACM F 300-57±25 RC	3-101-095	300	57	50	2°/1°	∞ to ±3,6m	
ACM F 300-57±25 RC/FC	3-101-195						
ACM F 500-57±25	3-101-066						
ACM F 500-57±25 RC	3-101-096	500	57	50	1,2°/0,6°	∞ to ±5m	
ACM F 500-57±25 RC/FC	3-101-196						
ACM F 1000-115±25	3-101-068						
ACM F 1000-115±25 RC	3-101-098	1000	115	100	0,6°/0,3°	∞ to ±20m	
ACM F 1000-115±25 RC/FC	3-101-198						



Focusing Autocollimator with Reticle Changer (RC) and Filter Changer (FC)

**FOCUSING AUTOCOLLIMATORS
WITH EYEPIECE MICROMETERS**

Flinite Distance Setting

Type	Code	Focal length (mm)	Tube diameter (mm)	Free Aperture (mm)	Focusing range	Measuring range/ Micrometer range	Resolution (arcsec)
ACM F 300-38±25 Micro	3-101-074	300	38,1	30	∞ to ±3,6m	1°/0,4°	1,7
ACM F 300-38±25 Digi	3-101-084						0,35
ACM F 300-57±25 Micro	3-101-075	300	57	50	∞ to ±3,6m	1°/0,4°	1,7
ACM F 300-57±25 Digi	3-101-085						0,35
ACM F 500-57±50 Micro	3-101-076	500	57	50	∞ to ±5m	0,6°/0,23°	1
ACM F 500-57±50 Digi	3-101-086						0,2
ACM F 1000-115±50 Micro	3-101-078	1000	115	100	∞ to ±20m	0,3°/0,11°	0,5
ACM F 1000-115±50 Digi	3-101-088						0,1

LARGE FIELD AUTOCOLLIMATORS

To meet customer requirements for testing optical instruments with large field of view, TRIOPTICS developed a new and unique line of autocollimators, collimators and telescopes

providing a significant increase of field of view. Equipped with suitable reticles the Large Field Autocollimators give for the same focal length a field of view larger by 50-100% compared with the standard line.

Type	Code	Focal length (mm)	Tube diameter (mm)	Free Aperture (mm)	Field of View/Measuring range	Resolution for reticle line width 10 µm (arc sec)
ACM 300-57 LF	3-100-265	300	57	50	3°/1,5°	3,5
ACM 500-57 LF	3-100-266	500	57	50	2,4°/1,2°	2
ACM 1000-115 LF	3-100-268	1000	115	100	0,9°/0,45°	1

LED-AUTOCOLLIMATORS

The LED-Autocollimators are light, compact Autocollimators made according MIL-Standards (high and low temperature, shocks, hu-

umidity etc). The LED-Illumination enable a practically unlimited life period. The power supply is possible at 12V or 24V or ensured by a battery.

Type	Code	Focal length (mm)	Tube diameter (mm)	Free Aperture (mm)	Field of View/ Measuring Range	Resolution for reticle line width 10 μ	Beam Splitter in Mount with reticles
ACM 140-40 LED	3-100-362	140	40	30	4°/2°	7 arcsec	



Delivery Kit

The Autocollimators are delivered as complete -ready to work-instruments including following parts: :

- Tube mounted objective lens
- Beam splitter mount with reticles and eyepiece micrometers*
- Eyepiece
- Illumination device with green filter and 5W/6V bulb

*for Autocollimators with eyepiece micrometers only

Optional Items

- Power supply (Transformer) for Illumination
- Eyepieces with magnification 10x, 12x and 25x
- Holders
- Other illumination devices (cold light source 150W, halogene illumination 20W)
- Additional achromats in mount fitting on the objective lens tube
- CCD-camera attachment
- Mirrors



The available Beam **Splitter Mounts** are of different types : Standard Beam Splitter Mount including two reticle at choice



RC-Beam Splitter Mount with illuminated Reticle Changer (4 positions for collimator reticles) and one eyepiece reticle. Five reticles at choice are included.



RC/FC-Beam Splitter Mount with illuminated Reticle Changer . Filter Changer with 4 positions. One green and one white diffuser are included. Further filters on request.



Large Field Beam Splitter Mount including two reticle at choice

Ordering Information

To order an autocollimator please specify:

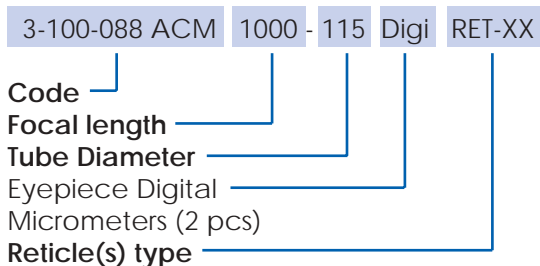
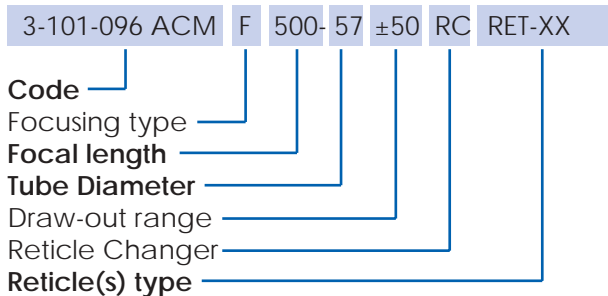

DIOPTER TELESCOPES

Operating Principle and Applications

The Diopter Telescope or Dioptrimeter is a focusing telescope measuring the power of lenses in diopters. The results of the measurement can be read off on a graduated scale.

The Diopter Telescopes have wide applications in the field of optical testing. Most important applications include:

- Testing diopter graduation, focusing range and infinity („zero“) setting of eyepieces.
- Measurement of power of lenses
- Testing the astigmatism of telescopes
- Measuring the field curvature of lenses

The measurements with Diopter Telescopes include following steps:

- the eyepiece of the Diopter Telescope is rotated until its reticle is seen sharp and clear. The focusing ring is set to zero.
- the Diopter Telescope is placed with its supporting flange on the eyepiece or the telescope under test. The eyepiece of the telescope under test is rotated until its reticle is seen sharp and clear. This is the zero setting of the eyepiece.
- Further measurements are made by rotating the eyepiece under test to the next graduation and focusing the Dioptrimeter correspondingly. The reading is done directly on the diopter graduated scale.

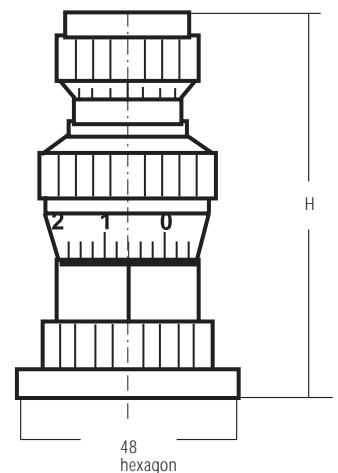



Product Range and Specification

The supporting flange of TRIOPTICS Diptometers is hexagonal (48 mm wide) and removable. After removing the flange, the connection thread M 38x1 mm can be used to attach the Diptometer to custom holders or other devices.

The size of the smallest division is important for accurate reading. All TRIOPTICS Diptometers (except for 3-100-298) have large graduations and permit easy reading and accurate estimation at half of the smallest division. The eyepieces are interchangeable and can be adapted to custom needs.

Type	Code	Focal length (mm)	Field of View	Height H (mm)	Measuring range / (Diopter)	Graduation (Diopter)
DPT-5/+5	3-100-295	40	13°	75-92	-5 to +5	0,2
DPT-3/+1	3-100-296			82-90	-3 to +1	0,1
DPT-1/+3	3-100-297			77-83	+3 to -1	0,1
DPT-5/+5	3-100-298			75-92	-5 to +5	0,1

DYNAMETER

The Dynameter is used in optical testing for:

- Measurement of the diameter of exit pupil of optical instruments
- Checking the distance between eyepiece and exit pupil
- Measurement of magnification of telescopes

Type	Code	Magnification	Distance range	Diameter range	Reticle
DYN 90	3-100-291	12 x	90mm, div. 0,5mm	10mm	10mm with div. 0,1mm

**SQUARE BODY TELESCOPE
AND COLLIMATOR**



The collimators and telescopes with square body have a cross reticle accurately aligned to the body flat surface i.e. mechanical axis of the instrument. The square body is used as a reference surface in solving alignment problems. The telescope is normally equipped with

the standard eyepiece EPC 00-15 (magnification 16x). The collimator includes the standard illumination ILL 5W-6V. Further eyepieces and illumination devices of OPTITEST are available on request.

Type	Code	Focal length (mm)	Field of View	Free Aperture (mm)	Magnification	Alignment optical/mechanical axis
TEL 150-40x40	3-100-030	150	4°	30	9,5 x	>10arc sec
COL150-40x40	3-100-010	150	4°	30	-	>10arc sec

OPTO-MECHANICAL ASSEMBLIES AND COMPONENTS

The OPTITEST system is configured from basic opto-mechanical components which are modular, compatible to each other and common to most of the instruments.

The opto-mechanical components are specifically designed to allow instruments reconfiguration on site without any adjustments. The advantages of this modular approach are significant from point of view of flexibility and cost efficiency:

- to adapt the instruments to new applications might be sufficient to buy some components only, avoiding the costly procurement of a complete new instrument.

- setting up a modified instrument is easy and fast, since no adjustments are necessary.

- the OPTITEST system is continuously developed, so that new components and features (e.g. image processing) enhance the utility of existing instruments.

Description and technical data of the opto-mechanical assemblies and components of OPTITEST are presented on the following pages:

TUBE MOUNTED OBJECTIVE LENSES

The tube mounted objective lenses represent one of the main components of OPTITEST Auto-collimators, Collimators and Telescopes. Typical features of these basic elements are:

- barrel made of hardened steel with hard chrome surface



- front end surface accurately square to optical axis
- front end surface with female thread M35x0.75 mm (for barrels D 38 mm) and M53x0.75 (for barrels D 57 mm) to allow addition of accessories (achromats in mount, beam deflecting mirrors atc.). Similarly with the instruments described before, the tube mounted objective lenses are available in two different types:

- This position which corresponds to the „Infinity Setting“ is engraved on the scale of the focusing device as „0“.
- Moving the reticle away from objective lens will result in a convergent beam. The image of the reticle is real and projected at a finite distance. This region of the scale is marked as „+“ focusing range.

TUBE MOUNTED OBJECTIVE LENS

Infinity setting

Type	Code	Focal length Diameter (mm)	Length L (mm)	Free aperture (mm)
OBJ-100-38	3-200-001	f = 100 D 38	70	30
OBJ-150-38	3-200-002	f = 150 D 38	112	30
OBJ-200-38	3-200-003	f = 200 D 38	163	30
OBJ-300-38	3-200-004	f = 300 D 38	265	30
OBJ-300-57	3-200-005	f = 300 D 57	273	50
OBJ-500-57	3-200-006	f = 500 D 57	464	50
OBJ-1000-115	3-200-008	f = 1000 D 115	980	100

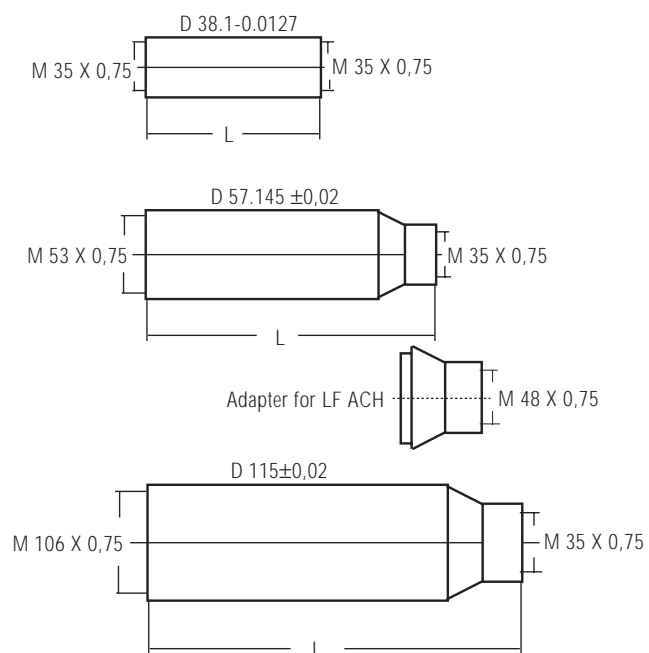

- The first type represents objective lenses mounted in barrels having fixed length. The barrel length is designed such, that when attaching the reticle adapter to the barrel, the reticle is in the focal plane of the objective lens and the emerging beam is parallel. The reticle image is projected to infinity. This type of adjustment is known as „Infinity Setting“.
- The second type of objective lenses is similarly built, however, a focusing device attached to the tube (barrel) containing the objective lens, allow for variation of the distance between the reticle and lens. The focusing range is normally selected so that in the mid position the reticle is placed in the focal plane of the lens.

- Moving the reticle toward the objective lens will result in a divergent beam. If the beam diverges, a virtual image is produced at the apparent crossing point of the beam rays. This point is also located at a finite distance. This region of the scale is marked as „-“ focusing range.

This type of adjustment is known as „Finite Distance Setting“.

TUBE MOUNTED OBJECTIVE LENS

TUBE MOUNTED OBJECTIVE LENSES WITH FOCUSING DEVICE

Finite Distance Setting

Type	Code	Focal length Diameter/Draw Out (mm)	Length L (mm)	Free aperture (mm)
OBJ-F300-57	3-201-005	f = 300 D 57±25	259	50
OBJ-F500-57	3-201-006	f = 500 D 57±50	469	50
OBJ-F1000-115	3-201-008	f = 1000 D115±50	948	100

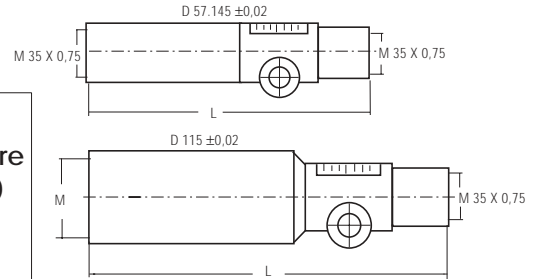

ACCESSORIES

for tube mounted objective lenses

For the tube mounted objective lenses of the OPTITEST line a large selection of accessories is available:

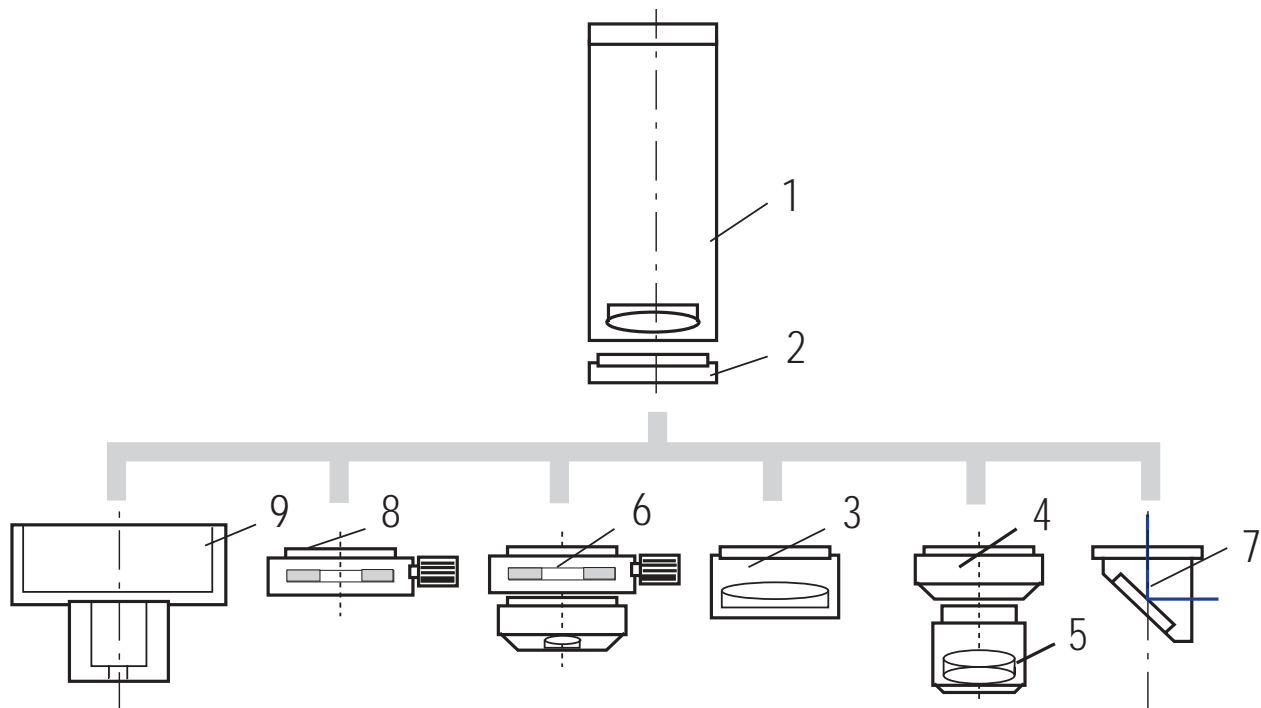

- 1- Tube mounted objective lens D 38mm
- 2- Front cover ring
- 3- Achromat in mount
- 4- Adapter for micro-objectives
- 5- Micro-objective
- 6- Dual Adapter
- 7- Mounted deflecting mirror
- 8- Iris diaphragm in mount
- 9- Laser Alignment Attachment

ACHROMATS IN MOUNT

The OPTITEST achromats are highly corrected objective lenses mounted in a cell having a mechanical interface (thread M 35x0.5 mm) fitting to the end of the objective lens barrel. The achromats in mount can be used for general purpose measurements or in connections with the OPTITEST autocollimators, collimators and telescopes.

After removing the front cover ring of the ob-

jective lens tube, the achromats in mount can be directly screwed on it. The parallel beam emerging from objective lens tube is now focused in the focal plane of the achromat. Typical applications for this set up:

- radius measurement of spherical and cylindrical surfaces (autocollimators)
- reading or observation of processes (telescopes)
- measurement of FFD (flange focal



Type	Code	Focal length Diameter (mm)	Free aperture (mm)
AMT 50-38	3-200-070	50/38	18
AMT 100-38	3-200-071	100/38	30
AMT 150-38	3-200-072	150/38	30
AMT 200-38	3-200-073	200/38	30
AMT 300-38	3-200-074	300/38	30
AMT 500-38	3-200-077	500/38	30
AMT 300-57	3-200-075	300/57	50
AMT 500-57	3-200-076	500/57	50
AMT-1000-115	3-101-078	1000/115	100

distance) of camera lenses set to short distances (autocollimators)

- MTF measurements, etc.
- The range of achromats in mount is presented below:

Further achromats as AMT 140-38, AMT 275-40, etc. can be delivered on request.

DUAL ADAPTER



IRIS DIAPHRAGM

The Iris Diaphragm assembly contains an iris diaphragm adjustable between 2...30 mm. The Iris Diaphragm assembly can be attached to any tube mounted objective lens of OPTITEST. On the other side the Iris Diaphragm assembly has a mechanical interface fitting to :

- achromat mount of the Dual Adapter
- micro-objectives adapter
- achromats in mount of OPTITEST line

The Dual Adapter assembly incorporates:

- a Iris Diaphragm in mount with a connection thread to the end of objective lens barrel
- an achromat in a mount which has a circular (ring shape) aperture around the achromat.

When mounted on an autocollimator, the Dual Adapter allows for simultaneous observation of the autocollimation image (through the circular aperture around the achromat) and direct viewing of the surface structure (through the achromat) of the plate placed in the front of the autocollimator. For viewing only, the built in iris diaphragm is used. Closing the diaphragm covers the autocollimation beam, so that observation of the surface through the achromat is possible. Applications include the alignment of wafers and lens systems.

The working distance between the Autocollimator and the surface under test depends on the back focal length (BFL) of the achromat mounted in the Dual Adapter. The range of achromats used in the Dual Adapter is from 10 to 200 mm. Further achromats for specific applications are available on request.

The Iris Diaphragm can be used to observe either the autocollimation image or the image on a surface at finite distance. It can be used as well to adjust the illumination intensity when measuring samples with different reflectivities.

ADAPTER FOR MICRO-OBJECTIVES

The Adapter for Micro-objectives enables the fitting of different micro-objectives to the objective lens barrel of the Autocollimator. In this way it is possible to focus the autocollimator beam on a surface placed at the working distance of the microobjective.



The Microobjectives have different magnifications and working distances to suit many applications : observation of structure of surfaces, measuring of radii of curvature of spherical surfaces, measuring of BFL, etc.

DEFLECTION MIRROR IN MOUNT

The Deflection Mirror in Mount is used to deviate the beam of autocollimators, collimators and telescopes by 90°. For this a mirror is mounted at an angle of 45° related to the optical axis of the instrument. The mount of the deflection mirror can be attached to the end of the objective lens tubes.

The Deflection Mirror in Mount increases the versatility of autocollimators and other instruments since these can be used for measurements in horizontal and vertical directions without exchanging the instrument holder.

LASER ALIGNMENT ATTACHMENT

The alignment of autocollimators to a mirror might be difficult, if the distance is long and the instrument has a long focal length (i.e. small field of view). The TRIOPTICS Laser Alignment Attachment can be easily mounted directly on the end of the objective lens barrel. A small laser diode is mounted inside concen-

trically with the mechanical interface to objective lens tube. The visible laser beam helps to align quickly the mirror or the autocollimator. The device is supplied complete including power supply.



Laser Alignment Attachment D 57 mm

	Type	Code	Technical Data
Dual Adapter	DA 8-38	3-200-026	Outer dia. 38 mm, Achromat dia 8 mm, Diaphragm 2-30 mm
Dual Adapter	DA 10-38	3-300-027	Outer dia. 38 mm, Achromat dia 10 mm, Diaphragm 2-30 mm
Iris Diaphragm	ID 2-30	3-300-025	Range 2-30 mm connection threads M 35 x 0,5 mm
Adapter for Microobjectives	AMO 38	3-300-070	Outer dia. 38 mm thread M 35 x 0,5 mm / thread 4,5" x 1/36"
Microobjective	Micro 3,2	3-300-073	Magnification 3,2 X Working Distance 31 mm
Microobjective	Micro 6,3	3-300-074	Magnification 6,3 X Working Distance 12 mm
Microobjective	Micro 10	3-300-075	Magnification 10 X Working Distance 7,5 mm
Deflection Mirror	DMF 38	3-300-091	Mirror dia 36 mm, $\lambda/6$
Deflection Mirror	DMF 57	3-300-092	Mirror dia 75 mm, $\lambda/5$
Laser Alignment Attachment	LA 57	3-300-095	Max. distance: 25 m

RETICLE ADAPTERS

RETICLE ADAPTERS

A Reticle Adapter is basically an assembly containing :

- one reticle in mount when designated for collimators and telescopes
- a beamsplitter and two reticles in mount for use in autocollimators
- mechanical interface for connection to tu be mounted objective lenses (M35x0.75mm)
- mechanical interface for connection with eyepieces and illumination devices (M27x0.5mm).



RETICLE ADAPTER FOR COLLIMATORS AND TELESCOPES

The Reticle Adapters for collimators and telescopes as well as the Beamsplitter Mounts for autocollimators come standard with dust covers when ordered separately.

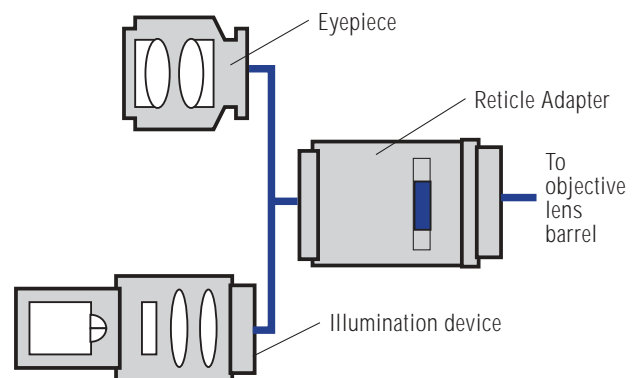

RETICLE ADAPTER FOR AUTOCOLLIMATORS BEAMSPLITTER MOUNTS

The **Beamsplitter Mount (BSP)** contains a beamsplitter and two reticles in mount for use in autocollimator. The Beamsplitter Mounts with the eyepiece and illumination forms an assembly known as Autocollimation Head. Some **Autocollimation Heads (ACH)** are illustrated below:

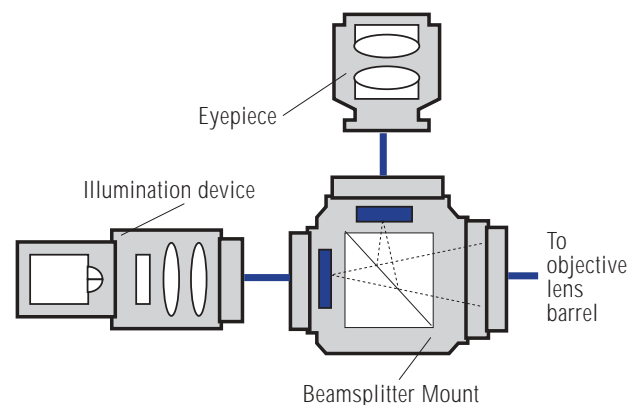

Type	Code	No. of reticles	Technical Data
RA	3-200-041	1	Standard Reticle Adapter. It contains one fixed reticle.
90°-RA	3-200-042	1	90°-Standard Reticle Adapter. A beamsplitter is used for beam deviation.
RA Micro	3-200-043	1	Reticle Adapter with two micrometers. Range for reticle displacement: 4mm. Resolution: 0,005 mm
RA-RC	3-200-045	4	Reticle Adapter with Reticle Changer. The four reticles positioned by rotating indexing wheel
RA-RC/FC	3-200-046	4	Reticle Adapter with Reticle Changer and Filter Changer. The 4 reticles and 4 filters positioned by rotating indexing wheels. Standard included: one green filter, one diffuser. Two filter locations empty. Filter dia. 20 mm



Autocollimation Heads From left:
 Standard Autocollimation Head (ACH)
 90°-viewing
 ACH with eyepiece micrometers
 ACH with Reticle and Filter Changer
 Standard Autocollimation Head (ACH) direct
 viewing



Large Field ACH / Standard ACH

Beamsplitters in Mount

Type	Code	No. of reticles	Technical Data
BSP	3-200-031	2	Standard Beamsplitter Mount with Straight or 90°-viewing. It contains two fixed reticles.
LF BSP	3-200-231	2	Large Field Beamsplitter Mount with straight or 90°-viewing. It contains two fixed reticles
BSP Micro	3-200-033	2	Beamsplitter Mount with two micrometers. Range for reticle displacement: 4mm. Resolution: 0,005 mm. With straight or 90°-viewing. It contains 1 reticle translatable in two axes and one fixed reticle (collimator reticle)
BSP Digi	3-200-034	2	Beamsplitter Mount with two digital micrometers. Range for reticle displacement: 4mm. Resolution: 0,001 mm. With straight or 90°-viewing. It contains 1 reticle translatable in two axes and one fixed reticle (collimator reticle)
BSP-RC	3-200-035	5	Beamsplitter Mount with Reticle Changer. It contains 1 eyepiece reticle and 4 collimator reticles. The 4 reticles positioned by rotating indexing wheel
BSP-RC/FC	3-200-035	5	Beamsplitter Mount with Reticle Changer and Filter Changer. It contains 1 eyepiece reticle and 4 collimator reticles. The 4 reticles positioned by rotating indexing wheels. Standard included: one green filter, one diffuser. Two filter locations empty. Filter dia. 20 mm

EYEPIECES



EPC 00-15 (standard)
EPC 00-20
EPC 00-25

The range of eyepieces included in the OPTI-TEST line provides capabilities for many applications requiring different parameters as :

- large field of view
- large magnification
- facilities for attaching CCD-cameras, etc.

15 is the standard fit for OPTITEST instruments.

- Magnification of the eyepiece:

$$M = \frac{250}{f \text{ eyepiece}}$$

- Magnification of autocollimators and telescopes

$$M = \frac{f \text{ lens}}{f \text{ eyepiece}}$$

The eyeshield is removable. After removal, the thread of the eyepiece tube (M 28x0.75) can be used to attach a CCD-camera adapter.

CCD-CAMERA ADAPTER

This device includes highly corrected imaging optics which transfer the reticle image from



All the eyepieces are focusable and have a long eyepoint which is convenient for spectacle lens wearers. A diopter scale can be used for various measurements like astigmatism, flatness errors etc. The eyepiece EPC 00-

the eyepiece on CCD-array. The Camera Adapter has a mechanical interface to CCD-Camera (C-mount) and a threaded mount (M28x0.75) to eyepiece. The imaging optics are interchangeable (factory assembly).

Eyepieces

Type	Code	Focal length (mm)	Magnification	Linear Field	Diopter Scale	Connection Thread
EPC 00-10	3-200-050	10,3	25 x	10	±5 dpt.	M 27x0,5
EPC 00-15	3-200-052	15,8	16 x	10	±5 dpt.	M 27x0,5
EPC 00-20	3-200-054	20,7	12 x	15	±5 dpt.	M 27x0,5
EPC 00-25	3-200-056	25,0	10 x	17	±5 dpt.	M 41x0,75

A complete Video Attachment includes:

- CCD-Camera-Adapter
- CCD-Camera (standardly 2/3" monochrome. On request other types)
- TV-Monitor, monochrome, CCIR
- BNC-Cable to connect camera and monitor
- Power supply for camera

Type	Code
Video Attachment complete	3-300-060
CCD-Camera Adapter with imaging optics	3-300-061

ILLUMINATION DEVICES

Standard illumination and Illumination for Large Field Instruments

STANDARD ILLUMINATION.

The standard illumination device of OPTITEST normally includes:

- condenser optics
- a green filter with a ground side working as difusser
- illuminating lamp in socket
- connection cable to power supply. Length 1 m.



The tube containing the filter is directly screwed on the illumination housing. The standard green filter can be easily exchanged if necessary.

Standard illumination

Type	Code	Filter Diameter (mm)	Connection thread	To be used
ILL 5W-6V	3-200-150	20	M 27 x 0,5	Standard Instruments
LF-ILL 5W-6V	3-200-151	20	M 41 x 0,75	Large Field Instruments

The Power Supply for standard illumination is an adjustable transformer which allow for adapting the light intensity to the specific application. The transformers include the powercable.

Transformers

Type	Code	Adjustment range	Power Voltage
Trafo 220	3-200-153	2 - 6V	220V / 50 Hz
Trafo 110	3-200-154	2 - 6V	110V / 50 / 60 Hz

FURTHER ILLUMINATIONS

In some applications the light intensity of the standard illumination might not be sufficient. This is the case in procedures requiring auto-collimation with a small (uncoated) reflector or long distances between reflector and auto-collimator. A need for more light is also related to collimators with very long focal length or alignment of complex optical systems. For these or similar applications following illumination devices with halogene lamps are recommended.

The fiber optic guide of the Cold Light Source with an effective diameter of 8 mm has an adapter fitting into the housing of standard illumination, so that the filter and condenser of standard illumination are further actively used with this light source.

The Halogene Illumination HAL 20W is delivered with own filter tube and green filter. When exchanging HAL 20W against the standard illumination, the filter tube of standard illumination must be removed and its own filter mounted instead.



Power Supply for Standard Illumination
 Cold Light Source with Fiber Optic Guide
 Halogene Illumination with Power Supply

Type	Code	Adjustment range	Features	Power Voltage
CLS 150 W/220V	3-200-158	continuous Range graduated in 50 divisions	Cold Light Source, complete incl. power supply, halogene lamp 150W, reflector optimised for range approx. 400-800nm, flexible fiber optic guide 1m length, adapter fitting into the housing of standard illumination	220V / 50 Hz
CLS 150W/110V	3-200-159	continuous Range graduated in 50 divisions	As above, however power supply voltage 110V	110V / 50 / 60 Hz
HAL 20 W	3-200-160	continuous 10 steps	Halogene lamp 20W in housing, filter tube with green filter fitting on the housing of standard illumination	220/110V/50/60 Hz

RETICLES.

The OPTITEST line offers a comprehensive choice of reticles to meet any conceivable application. Custom glass reticles made to your specification also can be supplied in our instruments. The reticle combination used in an optical instrument is depends on application and the experience of the user. However some general rules and recommendations presented below are intended to help the user to solve this problem.

General rules and recommendations

- A bright cross reticle is especially suitable for applications where the light conditions are not optimal e.g. small reflector for autocollimation, long distance between autocollimator and reflector, AR-coated surfaces, etc. For any other applications a dark cross reticle is preferred.
- For same application, the use of instruments with longer focal length (smaller numerical aperture) will worsen the light conditions. Therefore always use cross reticles with thicker lines when focal length increases.
- The accuracy of reading increases when between two superimposed reticles (in symmetric position) a small bright gap is left. The thickness of a dark/bright cross or a single/double cross combination should be selected correspondingly.
- The use of bright cross reticles (known also as dark field reticles) in eyepiece is not recommended since the observation of the collimator reticle is difficult.
- In the instruments with 90°-viewing using reticles with scales, the correct (erected) position of the scale numbers depends on the working position i.e. horizontal or vertical assumed by the assembly of the instrument. Therefore the working position of these instruments must be specified when ordering.

Important!
Read always our recommendations as follows :

- first reticle is eyepiece reticle
- second reticle is collimator reticle.

1. CROSS LINE (HAIR) RETICLES

APPLICATIONS

- Alignment of mirrors and optical systems
- Precision measurement of angles in combination with eyepiece micrometers
- Radius measurement of cylindric surfaces
- Measurement of centration errors
- Ideal for PC-controlled angle measurements

 TRIOPTICS Optiangle

RECOMMENDATIONS

- Eyepiece reticles: double cross line
- Collimator reticles: single cross line
- Preferred combinations:

RET-24/RET-02
RET-24/RET-12
RET-24/RET-13
RET-02/RET-12
RET-22/RET-01(f < 300 mm)

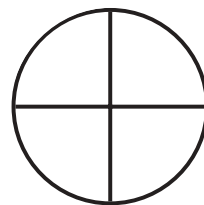

Dark Cross Reticle
(Positive Type)

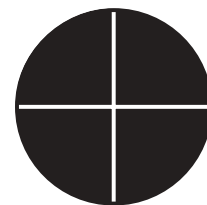



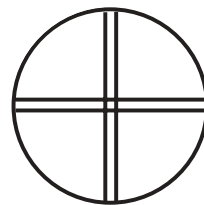







Bright Cross Reticle
(Negative Type)





Double Cross Reticle
(Positive Type)

Single Cross Line (Hair) Reticles

Code	Type	Line with (mm)	Dia (mm)
RET-01		0,010	12
RET-02		0,020	12
RET-04		0,040	12
RET-82		0,020	25
RET-85		0,050	25
RET-11		0,010	12
RET-12		0,020	12
RET-13		0,030	12
RET-15		0,050	12
RET-86		0,020	25
RET-87		0,050	25

Double Cross Line (Hair) Reticles

Code	Type	Clear Space (mm)	Dia (mm)
RET-22		0,020	12
RET-24		0,040	12
RET-26		0,060	12

2. RETICLE WITH ANGLE GRADUATED SCALES

APPLICATIONS

- Tilt measurement in conjunction with a reflector attached to the object under test
- Angle measurement of optical components like prisms, windows, etc.

 TRIOPTICS AUTOCOLLIMATORS

RECOMMENDATIONS

- Eyepiece reticles: angle graduated scales
- Collimator reticles: single cross line : RET-02 (RET-01, RET-12, RET-04)
- Preferred combinations: Angle graduated scales/RET-02

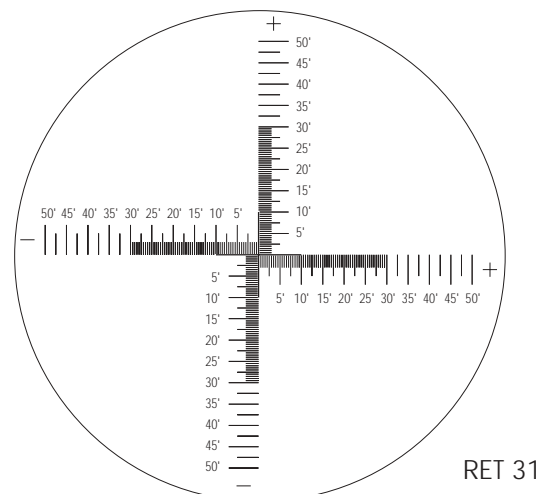
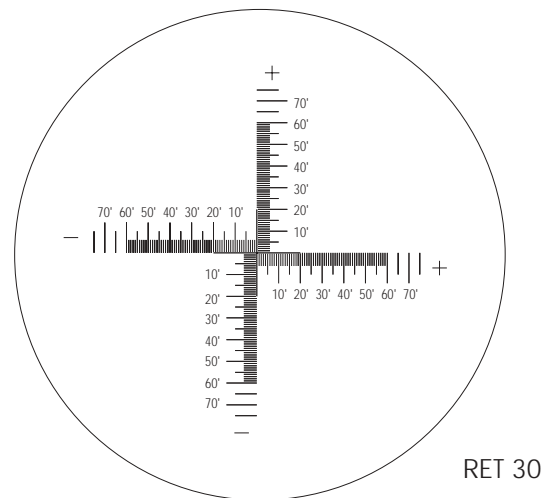

2. RETICLE WITH ANGLE GRADUATED SCALES (continued)

Angle graduated scales				
Code	Range of graduation	Smallest division	Estimation	Designed for instrument
RET-30	±75 min	60 sec	20 sec	ACM 100
RET-31	±50 min	30 sec	15 sec	ACM 150
RET-32	±30 min	30 sec	10 sec	ACM 200
RET-33	±25 min	30 sec	10 sec	ACM 300
RET-35	±12,5 min	15 sec	5 sec	ACM 500
RET-39	±7,5 min	5 sec	1,5 sec	ACM 1000
Reticle with special angle graduations				
RET-40	±20′	1′	0,5′	ACM 100
RET-42	±12′	0,5′	0,2′	ACM 200

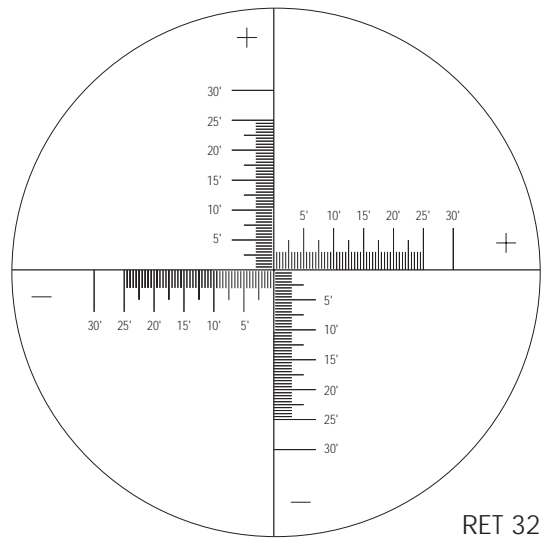

RET 32

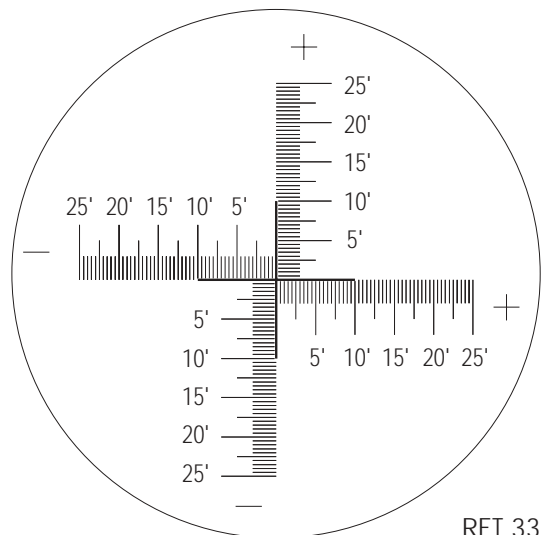

RET 33

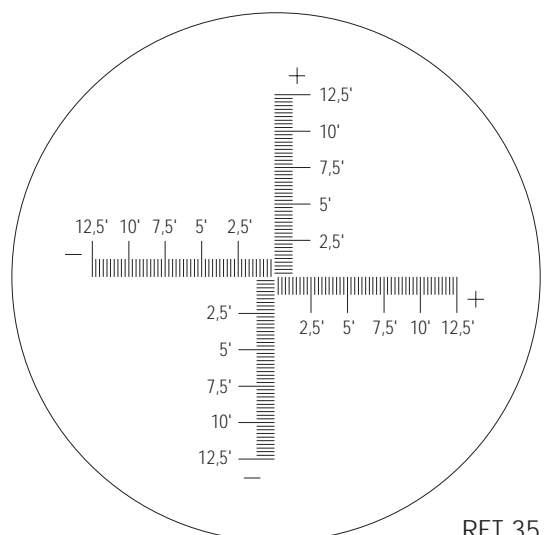

RET 35

3. RETICLE WITH ANGLE TOLERANCES

APPLICATIONS

- Fast checking of wedges and plane-parallel plates. Each pinhole allows for checking two angles given by:
 - diameter of the pinhole
 - cross size (twice the pinhole diameter).
 These reticles are recommended for testing of large production quantities on „go“ „no go“ basis.
- Alignment of optical systems
- Measurement of radii of curvature

RECOMMANDATIONS

- Eyepiece Reticle: RET-50, RET, 51
- Collimator Reticle: pinhole with cross RET-53...59

Prefered Combinations

- RET-50/RET-59
- RET-51/RET-53...RET-58

Reticles with Angle tolerances

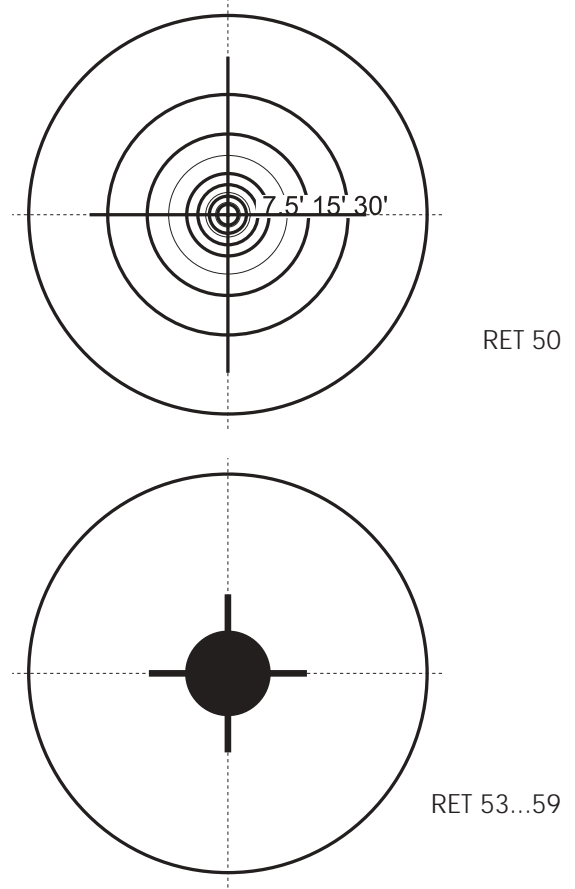

Reticles with angle tolerances			
Code	Type	Range of graduation	Designed for instrument
RET-50	9 concentric circles graduated for TILT measurement (positive type)	1, 2, 3, 4, 5, 7,5, 10, 15, 30, min	ACM 200
RET-51	9 concentric circles graduated for WEDGE measurement (positive type)	1, 2, 3, 4, 5, 7,5, 10, 15, 30, min	ACM 200
RET-53	pinhole with cross for WEDGE measurement (negative type)	30/60	ACM 300
RET-54	pinhole with cross for TILT measurement (negative type)	1/2 min	
RET-55		1,5/3 min	
RET-56		2/4 min	
RET-57		2,5/5 min	
RET-59		30/60 sec	ACM 200

4. RESOLUTION TESTS

Resolution Tests		
Code	Type	Diameter (mm)
RET-61	Siemens Star 2 x 36 segments Resolution 8,7 μm	12
RET 62	Siemens Star with crossline 0,02 mm 2x30 segments Resoluton10,4 μ	12
RET 63	USAF Resolution Test lpm (line pairs per mm) 0,504...0,0044	12
RET-67	Siemens Star 2 x 36 segments Resolution 8,7 μm	25
RET-68	USAF Resolution Test lpm (line pairs per mm) 0,504...0,0044	25

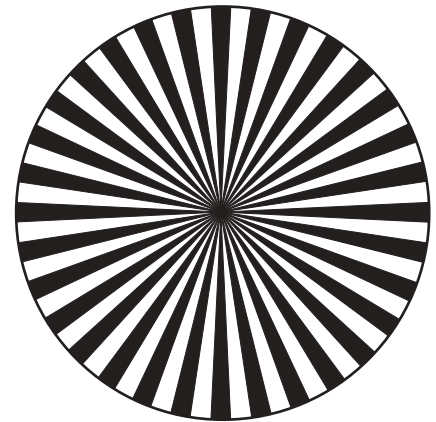

RET 61

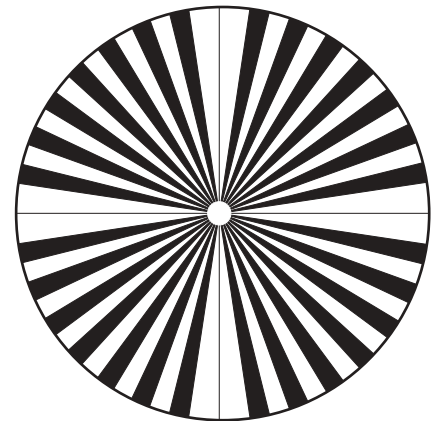

RET 62

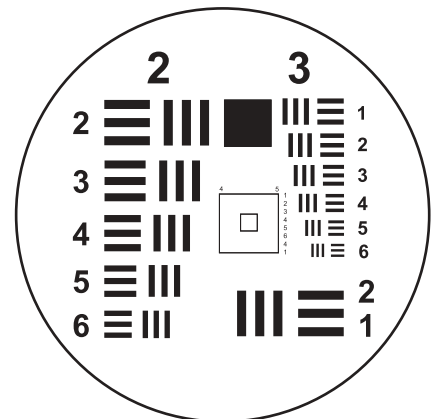

RET 63

Further resolution tests are available on request

APPLICATIONS

- Testing image quality of optical systems
- Adjustment and setting of optical instruments

RECOMMANDATIONS

- The resolution tests are always used as collimator reticle. When used in autocollimators, the eyepiece reticle should be a single cross.

5. SCALES IN MM AND FURTHER RETICLES USED IN OPTICAL TESTING
APPLICATIONS

- Measurement of optical parameter :
focal length : RET-73, RET-74, RET-91
centration errors: RET-71, RET-90
- Alignment of optical systems: RET-76, RET-77, RET-92

RECOMMANDATIONS:

- Eyepiece Reticle: mm scales
- Collimator Reticle: Porro plates, slits patterns, etc.

RETICLES

Preferred combinations:

- RET-71/RET-13(RET-02)
- RET-91/RET-13 (RET-02, RET-86)
- RET-02/RET-73

SCALES IN MM AND FURTHER RETICLES USED IN OPTICAL TESTING		
Code	Type	Diameter (mm)
RET-71	Crossed \pm 4mm scale. Range \pm 4mm Division 0,1mm	12
RET 73	Porro plate. Distance between line pairs: 2/4/6/8	12
RET 74	4 slits pattern, negative type. Width: 0,24/0,8 mm Distance: 2,4/8mm	12
RET-75	2 slits pattern, negative type. Width: 0,08 mm Distance: 0,5 mm	12
RET-76	Circle with cross, negative type. Diam. 0,8 mm, crosslines: 0,02mm	12
RET-77	Pinhole with positive cross Diam. 0,5 mm, crosslines: 0,01mm	12
RET 78	cross with circle, positive. Diam. : 1mm, crossline: 0,02mm	12
RET 90	Crossed \pm -5mm scale. Range \pm 5mm Division 0,1mm	17
RET-91	10mm Scale in 500 divisions. 1 division 0,02mm	15
RET-92	Cross with concentric circles. Diam.: 1,2,3,4,5,10,12,5 Linewidth:0,015mm	25



RET 74

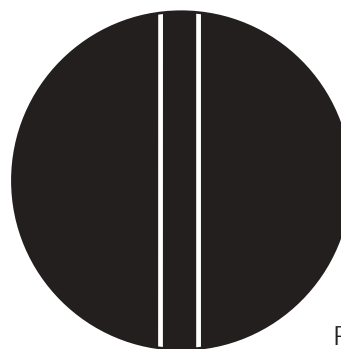

RET 75

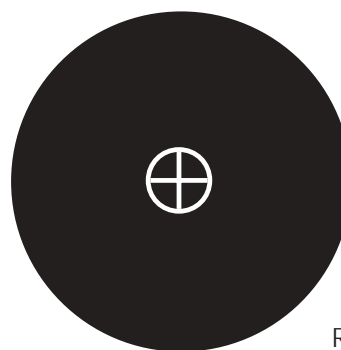

RET 76

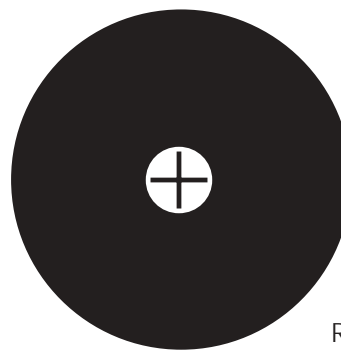

RET 77

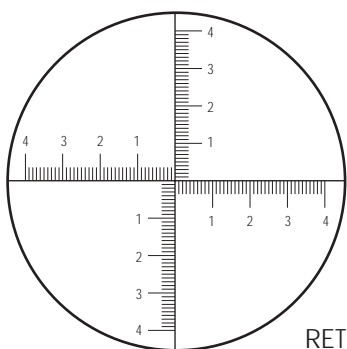

RET 71

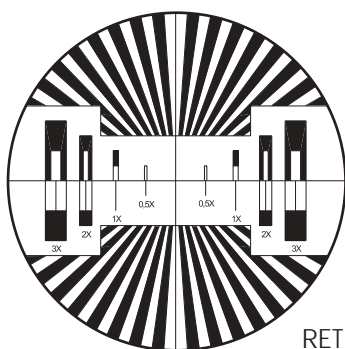

RET 73

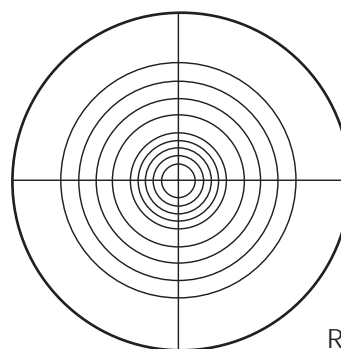

RET 92

ACCESSORIES. POSITIONING EQUIPMENT.

The OPTITEST line offers a wide range of accessories to solve positioning and alignment problems. In addition to the standard positioning equipment presented below, TRIOPTICS is supplying special holders and stands made according to specific customers requirements.

CLAMP FIXTURES

The clamp fixtures are mounted on a base plate with 4 fixing screws and 4 pressure screws. The pressure screws prevent a loosening of the fixing screws and allow a certain leveling within a small range.

Code	Diam. D mm	H	L	W	A	B
3-300-001	38	40	100	100	75	75
3-300-002	57	50	75	120	150	100
3-300-003	115	100	75	200	50	175

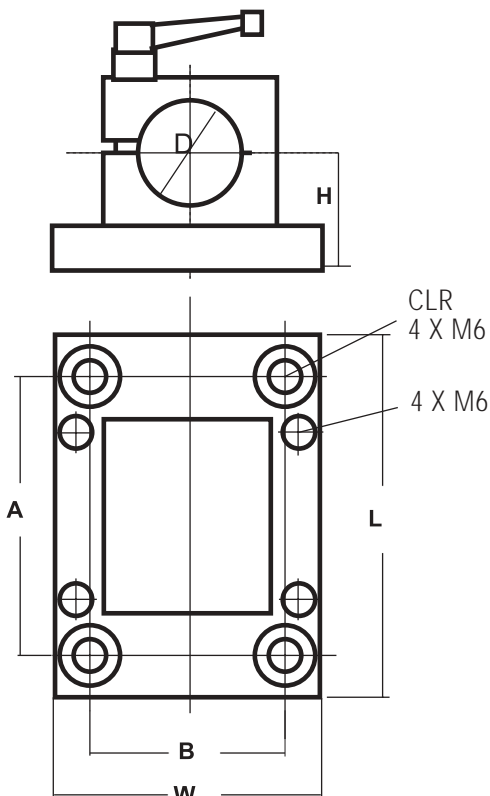

Various Clamp Holders

TWO AXIS ADJUSTABLE HOLDER

This unit provide two axis fine adjustments for azimuth and elevation. It also incorporates clamping screws to securely hold the autocollimator.



Adjustable Holder D 57 mm

Code	Diam. D mm	Adjustment range	Sensitivity
3-300-005	38	$\pm -1^\circ$	< 10 sec
3-300-006	57	$\pm -2^\circ$	< 1 sec
3-300-007	115	$\pm 1,5^\circ$	< 1 sec

AUTOCOLLIMATOR STAND

COARSE TRAVEL STAND (TYPE A)

Features

The Autocollimator Stand A is a simple stand featuring a precision rack and pinion slide mechanism for height adjustment of the autocollimator. The Stand A is equipped with a clamp fixture D 38 mm.

Further provisions are made for mounting of a tilt table D 100 mm. Alternatively a rotary table D 100 mm or a combination of tilt and rotary table can be mounted on the Stand A.

Applications

The Stand A is designated for angle measurements of plano optics as wedges, windows, prisms, etc.

FINE TRAVEL STAND (TYPE B)

Features

The Stand B has two travel mechanisms: a coarse travel and a coaxial ultra-fine focusing mechanism. The ultra-fine mechanism is especially useful in applications where a smooth, precise motion of optical instruments or subsystems are required. The bottom body of the stand contains a clamp fixture for a collimator D 38 mm and an adjustable mirror for beam deviation. A second clamp fixture D 38 mm attached to the travel mechanisms is used to hold autocollimators and telescopes.

Further accessories can be attached to the Stand B:

- tilt table
- rotary table
- precision self-centering rotary holder for centration measurements

Applications

The Stand B is ideal for measurements in transmission (centration errors) or reflection (radius, centration, etc) of spherical optics. Of coarse angle measurements of plano optics are also possible.



OptiAngle with Stand C

FINE TRAVEL STAND (TYPE C)

Features

The Stand C is similar with Stand B, however, two transversal translation stages with micrometer are supplementary provided. One of this stage allows to transversally move the clamp fixture with the optical instruments (mostly autocollimators or telescopes). The second stage is used to translate a reticle (mm scale) mount for measurement purposes.

Applications

The Stand C is ideal for measurements in transmission (centration errors) or reflection (radius, centration, etc) of spherical optics. The two additional micrometer stages are used for focal length measurements. In this case a Porro plate is mounted in the collimator located in the bottom body. The Porro pattern is projected over the sample to be measured. The reading is done using a microscope or telescope mounted on clamp fixture attached to the travel mechanism.

CONSTRUCTION

FINE TRAVEL STAND B (C)

- 1 - Coarse Travel Knob
- 2 - Fine Focusing Knob
- 3 - Clamping Knob
- 4 - Collimator clamb holder
- 5 - Deflection Mirror

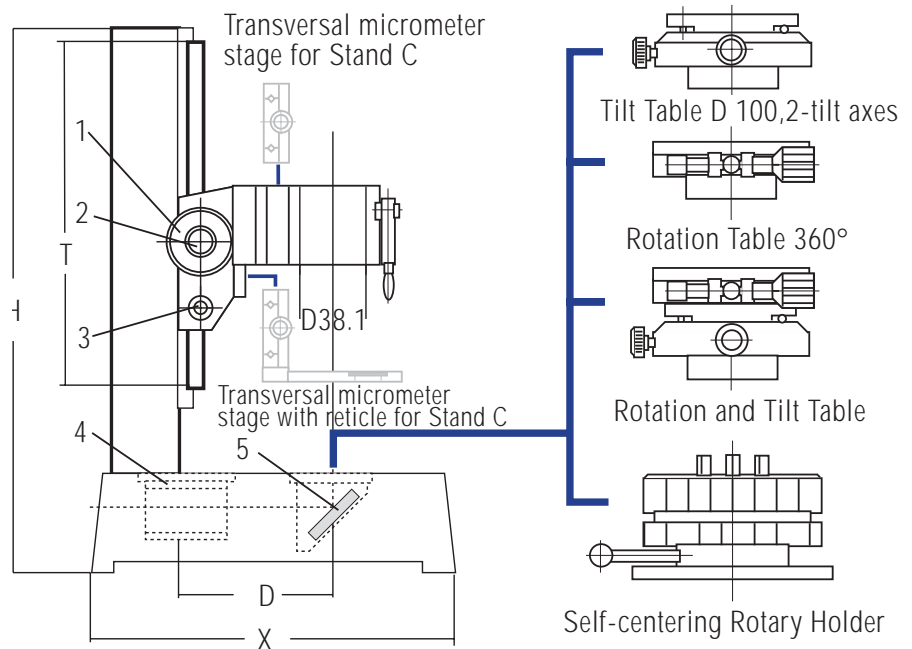

Type/Features	Code	Height H mm	Travel coarse/fine range T mm	Distance to optical axis D mm	L x W mm	Approx. Weight Kg
Stand A. Coarse travel only. Sensivity: 50 μm	3-200-030	465	225/-	80	225x115	6,5
Stand B. Coarse and fine travel. Sensivity: 1 μm	3-200-032	600	380/380	112,5	277x178	12
Stand C. Coarse and fine travel. Sensivity: 1 μm . Transversal Stages: $\pm 10\text{mm}$, Resolution 0,005 μm	3-200-034	600	380/380	112,5	277x178	13,5

TILT AND ROTATION TABLES

TILT TABLE D 100 MM

Three fine adjustments screws allow the tilt along two axes. Two threaded holes M4 are provided for attaching further accessories. The tilt table designed for measurements in transmission have a central hole D 15 mm.

ROTATION TABLE D 100 MM

The rotation table features complete 360° rotation. After clamping the table in the selected position, a tangential micrometer enables a fine rotation adjustment.

TILT AND ROTATION TABLE D 100 MM

The tilt and rotation tables are modular and can be mounted together with the tilt table either on top or at bottom.



Tilt and Rotation Table D 100, Rotation Table D 100, Tilt Table D 100, Wedge and Filter Holder Supporting Tables

Tilt on Rotation Table

Type	Code	Tilt Range	Rotation range coarse/fine	Sensitivity	Load Capacity	Approx Weight
Tilt Table D 100	3-300-010	± 2°	-	5 sec	8 Kg	1,6 Kg
Tilt Table D 100/ d 15	3-200-011	± 2°	-	5 sec	8 Kg	1,5 Kg
Rotation Table D 1000	3-300-014	-	360°/±2,5°	10 sec	10 Kg	1,8 Kg
Tilt and Rotation Table D 100	3-300-016	± 2°	360°/±2,5°	5/10 sec	8 Kg	3,4 Kg

SELF-CENTERING HOLDERS

Trioptics Self-Centering Lens Mounts reliably center and hold optics and cylindrical objects. The centering accuracy is far above the commercially available self-centering mounts. To ensure the precise axial position of lens cells and mounts, the three support rods have an accurately ground step. This secure not only a repeatable radial centration but an exact axial positioning as well.

Code	Type	Diam. range mm	Centration mm	Mounting
3-300-018	SCH 75	5-75	< 0,05	3xM4 CLR on Dia.110 mm

ULTRA-PRECISION ROTARY HOLDERS

Ultra-precision rotary holders

The Self-Centering Rotary Holders are designed for best possible centration and rotation accuracy required in measurement of centration errors of optical components and systems. The Self-Centering Rotary Holders incorporates an indexing mechanism at 90° for centration measurement with Trioptics automatic optical stations OPTOMATIC and OptiAngle. This indexing mechanism can be simply switched off when used in other applications.

Type	Code	Diam. range mm	Total error (centration + rotation)
PRH 01	2-100-021	0,5-13	1-3
PRH 02	2-100-023	13-34	1-3
PRH 03	2-100-025	34-54	2-4
PRH 04	2-100-027	54-75	2-4



The Rotary Holders come atandardly with two bell chucks. Further chuck fitting custom lens diameters can be provided on request.