

Tracer™ PV IV Software

Complete solar cell and module IV-curve tracing and analysis

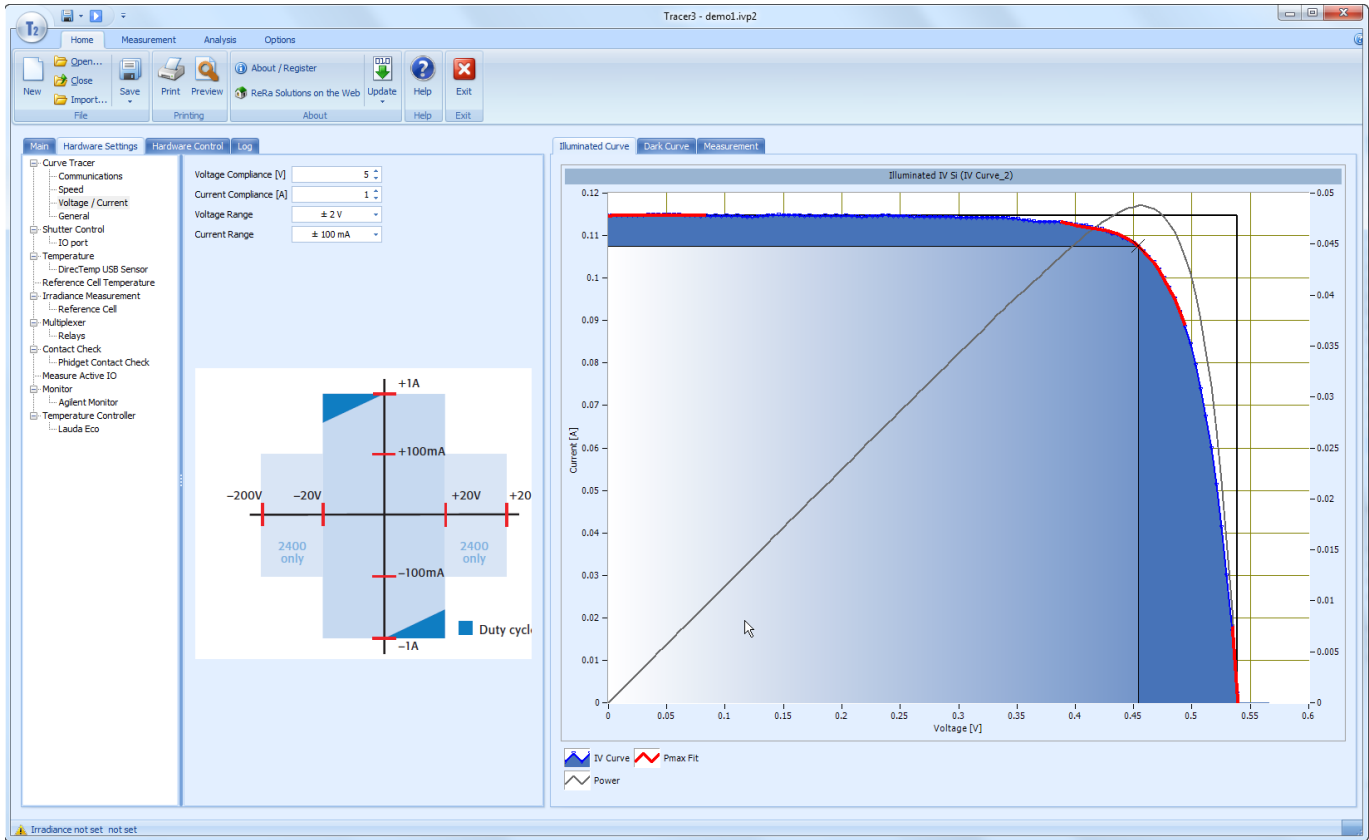

Tracer 3 – Power and Convenience

This third generation Tracer™ software package, Model 15000, builds on the field experience with the previous offerings and greatly simplifies hardware interaction while adding more data acquisition and analysis power.

In Tracer™ you will find your all-in-one solution for the measurement and elaboration of IV-curve measurements. Tracer™ natively supports all of the Abet offered electronic loads including the complete range of Keithley 24xx and 26xx SourceMeters™, Kepco bipolar amplifiers and Agilent DMMs.

Tracer™ was developed with the latest Microsoft.NET Technology, which resulted in a modern “Microsoft Office” look and feel and assures stable operation on the Microsoft Windows platform.

Computer Requirements

- Microsoft Windows 7 or higher
- Support for both x86 and x64 bit.
- Minimum Intel Core i3 (or similar), 2Gb memory

Elaboration algorithms

The algorithms used in Tracer meet the IEC-standards for Efficiency measurements. Different dedicated fitting algorithms to extract the two-diode model parameters are included. Spectral Mismatch correction is supported.

Organic cells

Since crystalline cell-based models may not represent organic materials quite as well Tracer™ supports import of additional fitting algorithms that may be better suited for analysis of these cells.

Tracer Analyzer

If you need to analyze your data away from the lab a lower cost Tracer Analyzer software package is available with all the analysis power of the standard package but without its instrument control features.

Hardware Configuration

The hardware configurator is a flexible tool which allows creation of a large number of different setups. The configuration can be a simple IV measurement system based on a Keithley Source-Meter™ and low-cost solar simulator. For the more expert user it is possible to configure Tracer to be used in a highly sophisticated setup, with contact checking, irradiance monitoring, multiplexing, motion control and temperature readout/control.

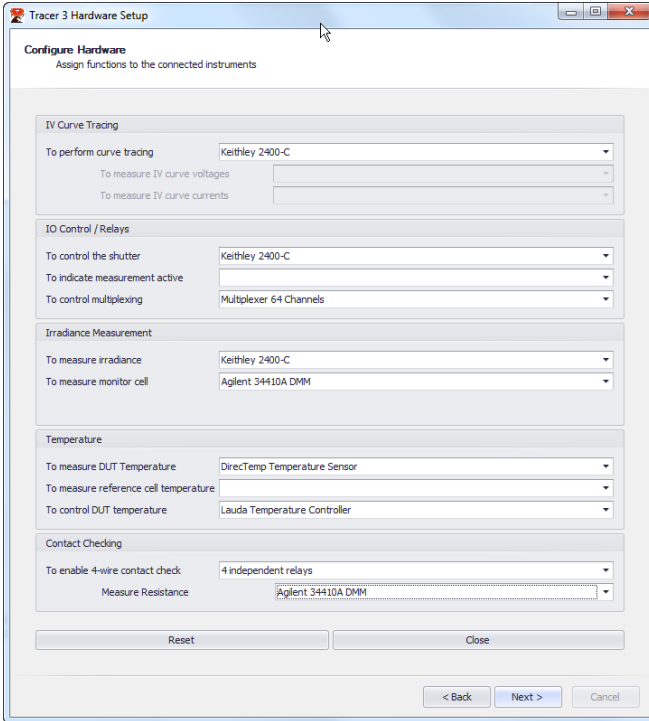

Tracer™ has the ability to control the following instruments:

- Complete range of Keithley Source-Meters™ (both 2400 and 2600 series) and Keysight source measure units
- Kepco Bi-Polar power supplies
- Common models of Keithley and Agilent DMM's and multiplexers
- DirecTemp high precision temperature sensors
- Lauda ECO liquid chiller/heaters
- All of Abet's applicable instruments (Reference Cells, Loads, Read Out units, Shutter Controllers, Module measurement systems, Temperature measurements devices, XY positioning tables and multiplexers)

Example: you have a Keithley 2400 Source-Meter™ and Agilent 34410A DMM available. You can configure Tracer™ to measure the solar cell by the front input of the Keithley 2400, use the rear input to measure the reference cell. Use the Agilent DMM to measure a Pt100 that is connected to your solar cell and also use it, with the help of an Abet multiplexer, for a continuous monitor cell.

- **Measurements: V_{OC} , I_{sc} , J_{sc} , V_{mpp} , I_{mpp} , FF, η , R_{sh} , R_s , n, Suns over V_{OC} , I vs. time, V vs. time and more**
- **IEC standards compliant correction to STC**
- **Wide range of Electronic Loads (Source-Meters) and Solar Simulators supported**
- **Single cell and module metrology**
- **Light and Dark curve measurement**
- **Long term measurements and light soaking**
- **Temperature dependency analysis**
- **Full database support (SQL, MySQL)**
- **Numerous solar cell material specific models included**
- **Integrated scripting engine**
- **Remote control (http) for simple integration in existing applications**

Automatic Data Storage

All data is stored in native project files. Export to many different file formats is included (.txt, .csv, .xlsx, etc....). Tracer™ supports the usage of MySQL or SQL Server databases. Our experts can help you set up a database system where all measurements are automatically stored. A simple viewer that shows the results in the database is included with the software package.

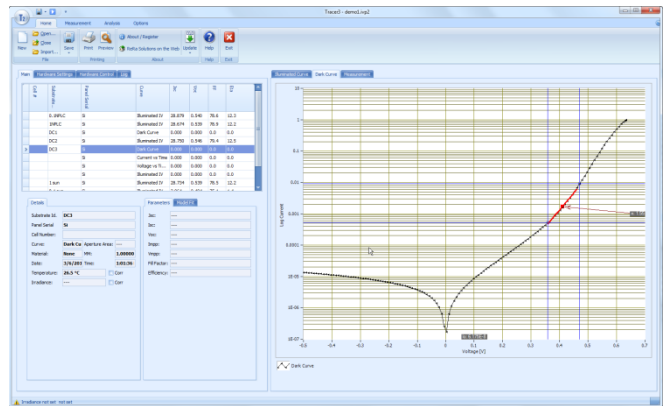

Tracer™ 3 Dark curve data screen

Components of a PV IV system

- Solar Simulator
- Electronic load
- Vacuum chuck
- Contact probes
- Data acquisition and analysis software
- Reference cell
- Temperature monitoring or control
- Dark enclosure
- Alignment microscope
- Motion control

A wide selection of PV IV system components is available from Abet Technologies to match the specific test requirements of different cell types and sizes. Some of those components, like our solar simulators, software and reference cells are more fully described on previous pages.

Here we focus on the remaining parts of the system.

Electronic load options

PV IV curves span a range of currents from pA levels to tens of Amps. Since not everybody needs to cover that whole range of values we describe the useful ranges for load options available from Abet.

Different models of Keithley SourceMeters™ cover a wide range of current levels. The more economical 2400 series SourceMeters™ work well with low to mid-range capacitance cells. Stabilizing circuits can be used to extend their load capacitance capabilities but at some cost to speed. The 2600 series units offer native High Capacitance mode, for up to 50 µF capacitance cells, and higher speed of operation. Keysight source measurement models offer competitive performance.

For higher current measurement ranges Abet combines a wide range of Kepco and other manufacturer's bipolar amplifiers with USB control circuitry and Keysight (Agilent) high speed DMMs to offer loads rated up to 125 A and 1000 W and still capable of dark curve generation.



Elements of Abet 15295 Universal load, 10A capacity

Our updated 15295 universal load combines two high speed Keysight (Agilent) 3446XA DMMs with a custom bipolar amplifier and a multifunctional USB interface to produce a selection of electronic load systems capable of dark curve and up to 125 A current metrology for up to 10 mF capacitance cells. Adding a third DMM allows simultaneous reading of a monitor cell.

In the table below, we list the current measurement specifications for some of the loads available from Abet. Please consult manufacturer's individual instrument data sheets for the full range of their specifications. Please ask us if you need a different load type.

Abet Standard Loads	Max current	Resolu-tion	Accu-racy
15295 Abet Universal Load, max. cell capacitance 1 mF	125 A	100 pA	40 nA
Keithley 2401 (and 2400)	1 A	50 pA	300 pA
Keithley 2440	5 A	500 pA	700 pA
Keithley 2601B	3 A	100 fA	100 pA
Keithley 2601B, 50 µF max. high cap. mode	3 A	1 pA	500 pA
Keithley 2635B	3 A	1 fA	120 fA
Keithley 2635B, 50 µF max. high cap. Mode	1.5 A	1 pA	400 pA
Keysight B2901A	3 A	100 fA	60 pA

All specifications subject to change without notice.

PV IV system chucks, stages and accessories

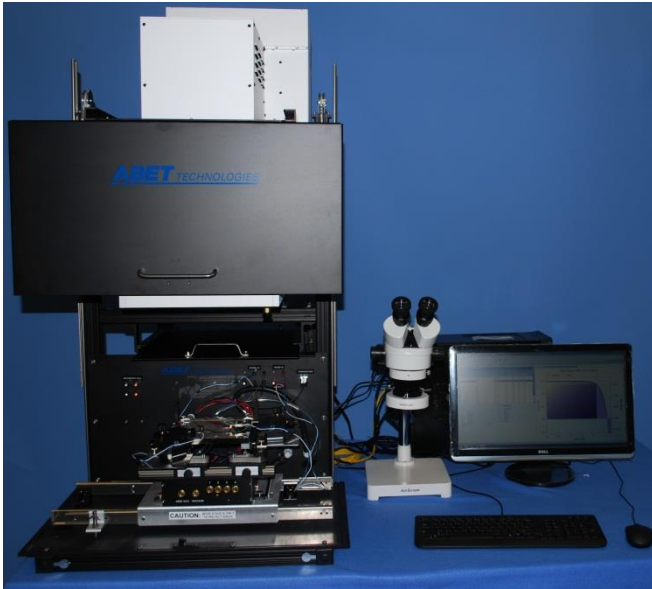

Abet Technologies 11018A Sun 3000 Solar Simulator with a 15514 Dark Enclosure with 15448 Slide assembly, 15510 Vacuum Chuck, 15511 Micromanipulator base, two 15250 Micromanipulators, 15552 Stereo Zoom Microscope, and a PC with Tracer™ PV IV software

Chucks and stages

Over the years Abet's standard selection of chucks developed for silicon solar cells has been complemented with many custom designs for newer technologies and these are now offered as standard products, too.

If you do not find what you need on the following pages, please let us know and we can quote yet another custom design.

Sandbox designs, placing a variety of test devices on a single substrate, are often used to cut the cost and speed up development efforts. Ossila 8-device substrates are an example of such technologies for thin film devices.

Abet Technologies developed a number of test arrangements to work with such devices, some with fixed contact pattern, some with variable position contacts.

Manual and electronic multiplexing options are available.

For thin film substrate, superstrate and sandwich devices we have a number of inexpensive mount and contact solutions.

Flip chuck option for ease of alignment.

Temperature monitoring and cooling options are offered when device mounting means allow.

- Vacuum chucks with zones for standard and custom cell sizes, 3 mm to 300 mm
- Four wire test methodology standard
- Top-bottom, top-top, and bottom-bottom contact geometries accommodated
- Electrical contacts: spring loaded bus bars, micromanipulators, custom probes
- Bus bar and micromanipulator options easily field switchable on 155XX chucks
- Dark enclosures
- Glove box compatible models
- Multi-cell devices multiplexing models
- Top, side or bottom illuminated models
- Flip chuck for ease of contact alignment
- Wide temperature range cooling/heating
- Basic models can be field modified for temperature control
- Calibrated temperature monitoring
- Attenuator for Bowden method of R_s determination included in many models
- Light color filtering options
- All tools and components for normal use and maintenance included

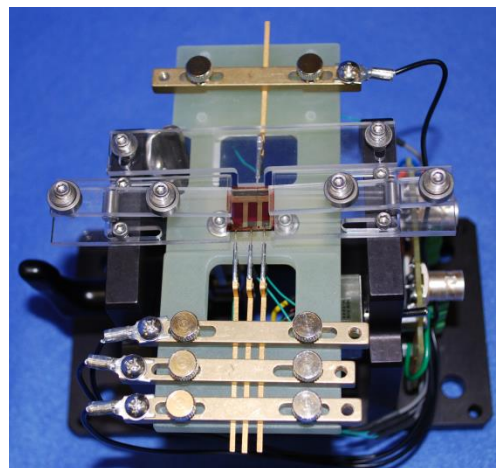

15545 Back contact, three device cells test station

Multiple device and sandwich cells test stations

Top-illuminated superstrate stages

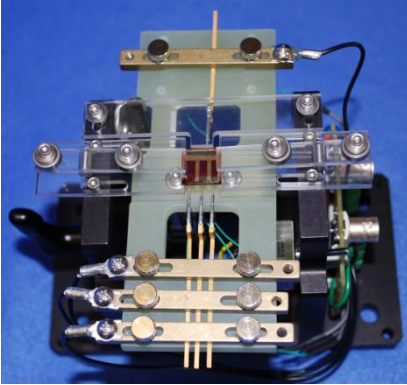

15545 Back contact, three device cells test station

The 15545 back contact station has adjustable contacts for up to three superstrate devices and one common contact. A three-position toggle switch allows selection of the DUT. Up to 25x25 mm cells can be accommodated.

We have designed many additional variants of this station for our customers allowing larger device sizes or more than three devices.

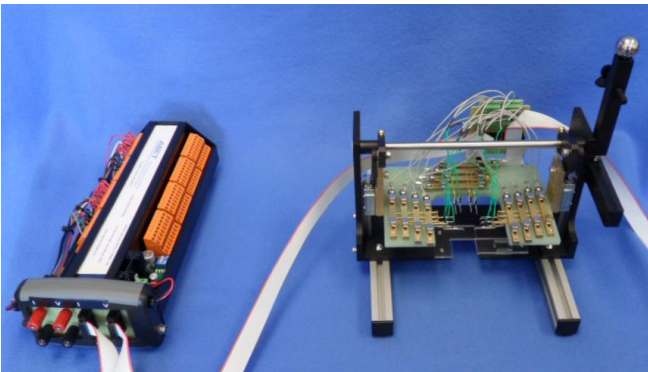

15545-B Adjustable back contact, eight device cells test station with 15277 multiplexer. Top or bottom illumination compatible.

Manual and computer controlled electronic multiplexing options have been shipped.

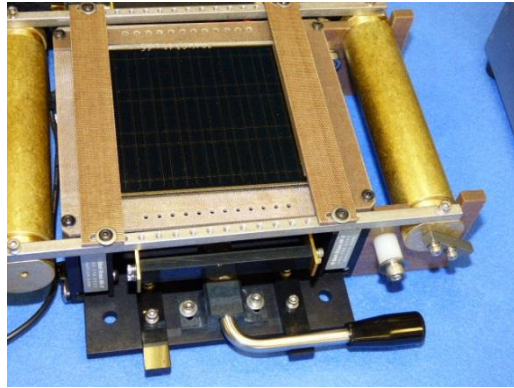

15545-MOD Mini-module test stage

The 15545-MOD allows testing of individual cells in a mini-module as well as the whole mini-module with the help of custom electronic multiplexer.

Abet Technologies model 15511 Vacuum Flip Chuck is used for back contact cells with small contact pads. The chuck allows contact alignment under a microscope and then is flipped 180° for top illumination. It is usually mounted on a slide to allow translation between the alignment and exposure locations. Alternatively, solar simulator and microscope can be slide mounted. Up to 50x50 mm active area can be probed on a maximum of a 100x100 mm substrate.

Two 15250 micromanipulators are required to contact the cell.

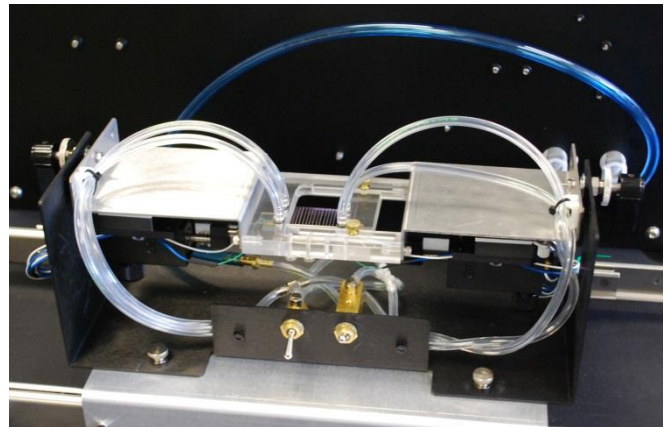

15511 Vacuum Flip Chuck with two 15250 micromanipulators on a 15448 slide assembly

DSSC and Thin Film Superstrate, Substrate or Sandwich device stages

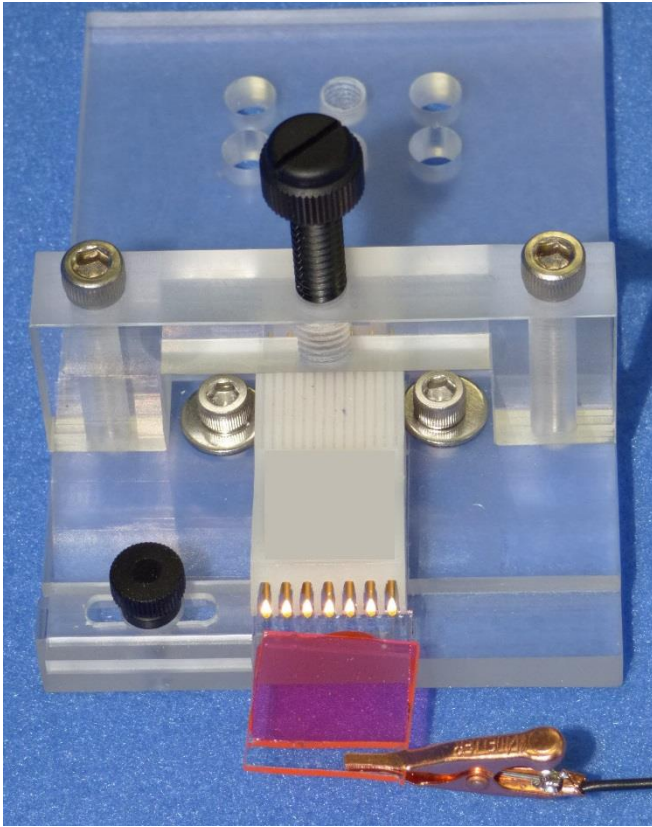

Abet Technologies' Model 15114 Stage with a DSSC cell

Simpler Design, Lower Price

Abet Technologies' model 15114 Stage facilitate testing of small solar cells with electrodes located on the sides. Standard version allows testing cells with 1-7 devices (set on 2.54 mm centers).

Stage is top or bottom illumination compatible.

Our design goal was to use the minimum necessary number of parts to make an easy to use fixture compatible with a large variety of solar cell device architectures. We think the picture tells the story.

This stage is compatible with solar cells of sandwich construction as well as superstrate and substrate thin film devices.

Gold plated rounded contact pads provide good electrical contact without damaging the thin film materials.

Manual and electronic multiplexing options allow quick testing of all the devices on a substrate. Tracer or Photor software sequences can be used to automate data acquisition.

- Low cost, flexible test fixtures
- Work with any solar cell with edges-located electrodes
- Top and bottom illumination compatible
- Allow multiplexing of 1-7 or 1-12 devices on 2.54 mm centers
- 1 mm to 5 mm thick devices accommodated
- Adjustable locator allows correct and reproducible device positioning
- Metric and English screw mounting compatible

Flexible and extendable capabilities

The design is easily adaptable to a larger number of devices per substrate (as long as the 2.54 mm spacing rule is obeyed). Thicker than 5 mm devices can be easily accommodated if Abet is notified at the time of ordering. Thinner than 1 mm devices can be easily accommodated with a number of design options which depend on the substrate fragility. Flip mounting options available if device architecture and illumination conditions require it.

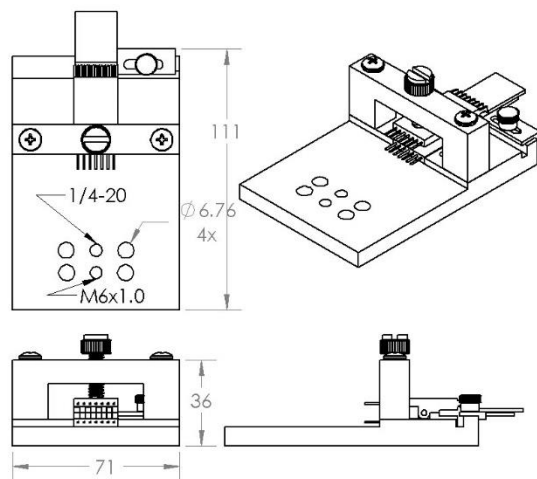

15114 stage dimensions

15114 Stage Specifications

Device size 3 – 25 mm
Device thickness 1 – 5 mm
Number of devices per substrate 1 – 7
Gold plated round contacts for thin film protection
Manual and electronic multiplexing options
Metric and English mounting accommodation included

Abet Technologies regularly continues to upgrade our products, therefore all specifications are subject to change without notice.

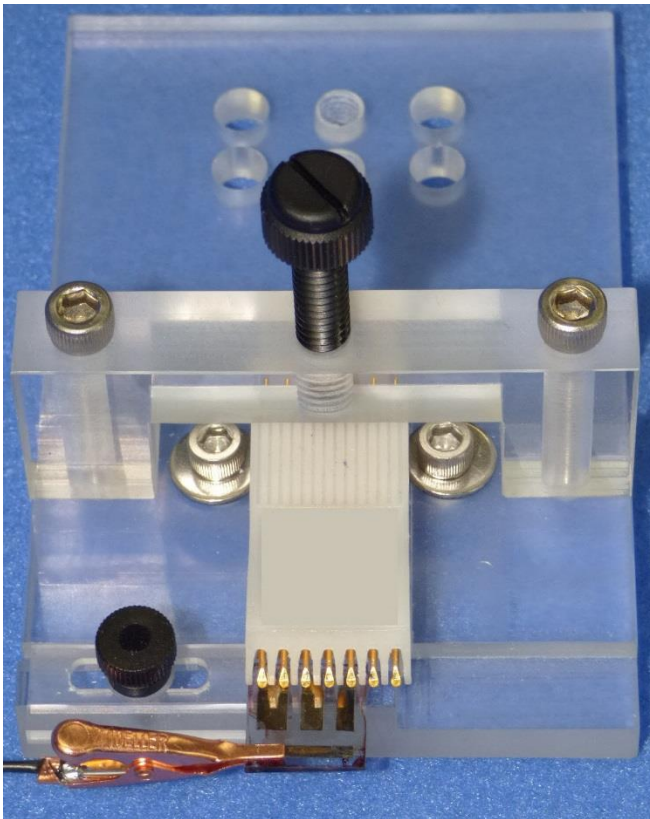

Abet Technologies' Model 15114 Stage with a three-device solar cell

15110 Stage Specifications

Device size 3 – 25 mm
Device thickness 1 – 5 mm
Number of devices per substrate 1 – 12
Gold plated round contacts for thin film protection
Manual and electronic multiplexing options

Abet Technologies regularly continues to upgrade our products, therefore all specifications are subject to change without notice.

The 15110 station, like the 15114, uses modified chip testing clips to contact device electrodes located on 2.54 mm centers. In this more robust system 14-contact clips (7 positions, top and bottom) are used. The signals can be selected manually or a 15277 Multiplexer, with 64 relays, 1A capacity, can be used to speed up test procedures under Tracer™ software control.

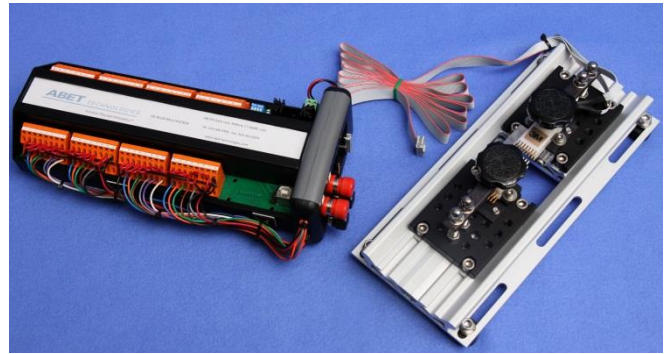

15110 station with 15277 Multiplexer

Ordering Information

15110	DSSC test stage, 2.54 spacing
15114	DSSC test stage, 2.54 spacing
15283	Manual multiplexer
15277	Electronic multiplexer
15151	Low cost reference cell
15151-KG5	Low cost reference cell with KG5 filter

Abet Technologies offers an expanding line of ASTM, IEC and JIS standards compliant products for solar cell PV-IV testing, steady state solar simulators, test stations, software, calibrated reference cells and a selection of electronic loads for low and high current cells. Visit www.abet-technologies.com or contact us at sales@abet-technologies.com.

Bottom illuminated stages for Ossila and similar devices

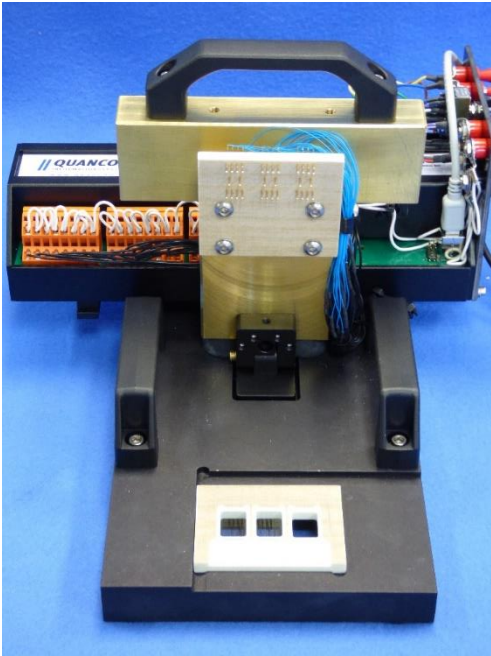

Abet Technologies 15114-3 test stage for three 8-device Ossila superstrate based solar cells with a 15277 multiplexer

Multiple device cell test stations

Sandbox designs, placing a variety of test devices on a single substrate, are often used to cut the cost and speed up development efforts. Abet Technologies developed a number of test arrangements to work with such devices. Here we show two of those.

The 15114-3 station accommodates up to three devices based on 8-device Ossila substrates.

The signals can be selected manually or a 15277 Multiplexer, with 64 relays, 1A capacity, can be used to speed up test procedures under Tracer™ software control.

- Multiple superstrate device stages
- Four wire test methodology standard
- Glove box compatible bottom illumination
- Electrical contacts: spring loaded probes
- 4 to 64 relay multiplexer options
- Reference cell locators assure irradiance measured at device level
- All tools and components for normal use and maintenance included

The 15114-4 stage accommodates a 15x15 mm substrate with 4 devices.

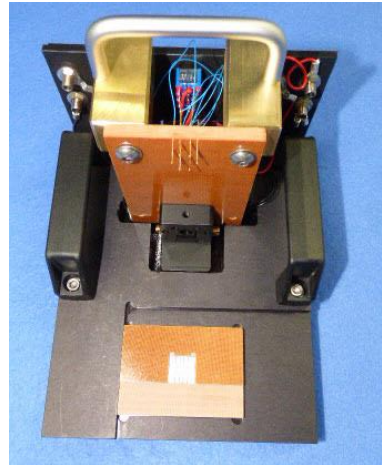

Abet Technologies 15114-4 test stage for a 15x15 mm 4-device superstrate based solar cell with a 4-relay multiplexer

Both stages are designed for bottom illumination for glove box compatibility.

A recessed locator area positions the 15150 series reference cell sensor at the same height as the devices being tested to assure correct irradiance metrology.

These very flexible designs can be easily modified for your devices if the contact geometry or device count is different. Please let us know your needs.

Universal PV IV Vacuum Test Platform

Abet Technologies Model 15090 Universal Test Platform with adjustable 15090-M magnetic bases and 15250F-L and 15251L micromanipulators.

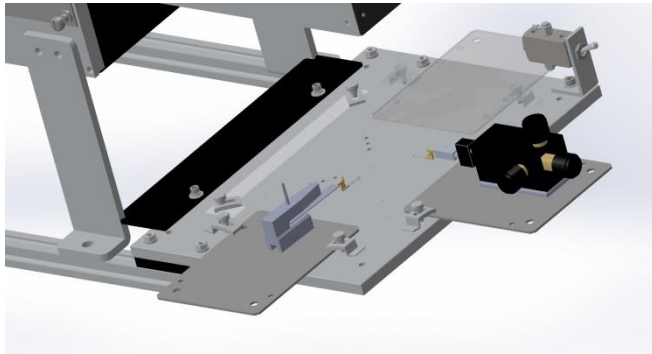

Adaptable Entry Level Tool

Reproducible cell positioning and reliable electrical contacts are key to meaningful metrology. The versatile 15090 Universal Test Platform offers those qualities for those with entry level budgets.

Reconfigurable vacuum zones

User can easily modify vacuum distribution to match cell sizes being measured: a single vacuum hole for the smaller cells, multiple vacuum holes for larger ones.

Electrically isolated

The chuck is electrically isolated to allow its use as one of the cell contacts. It can be mounted to the supporting rails on one of the Abet's Sun 2000 or Sun 3000 simulators or used free standing with the optional Model 15090-F levelling feet.

Micromanipulator ready

Use the basic platform with vacuum base micromanipulators or add the optional 15090-M magnetic bases to allow use with Abet's magnetic base micromanipulators. Base positions are adjustable to optimize micromanipulator locations.

The following micromanipulators are compatible with this test platform: the high resolution 15250F-L and 15250F-R models and the 15251L low resolution unit.

Locators included

Fixed position cell locators for 156x156, 125x125 and 100x100 mm cells as well as an adjustable locator for smaller cells are included with the basic product.

A positioning bar assures proper location under Abet's SunLite, Sun 2000 or Sun 3000 Solar Simulator.

Temperature monitoring ready

Attach the optional Model 15170 Calibrated temperature monitor for STC corrected metrology.

- Reconfigurable vacuum zones
- Locators for 3 mm to 156x156 mm cells included
- Accepts up to three magnetic bases
- Electrically isolated
- Four wire metrology ready
- Temperature monitoring available
- Hard Nickel plated for reliable electrical contact
- Free standing and simulator mounted options

Ordering Information

15090	Universal test platform, hard Nickel plated
15090-P	Universal test platform, insulating
15090-M	Magnetic base
15090-F	Levelling feet
15170	Calibrated temperature monitor
15250F-R	Micromanipulator, precision, right handed
15250F-L	Micromanipulator, precision, left handed
15251L	Micromanipulator, low resolution For 50x50 mm or smaller devices

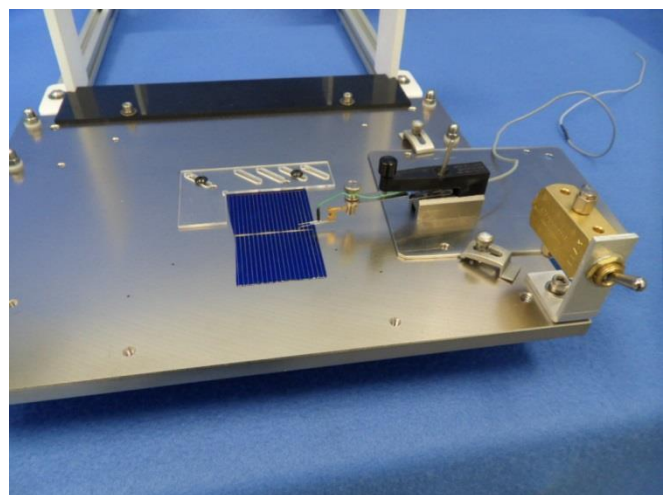

Abet Technologies Model 15090 Universal Test Platform with an adjustable 15090-M magnetic base and a 15251L micromanipulator

50x50 mm class Vacuum Chuck

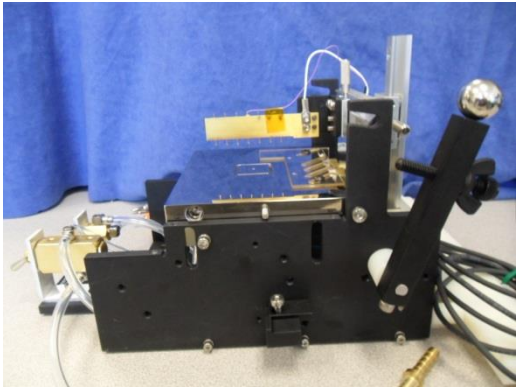

Abet Technologies' Model 15500 chuck with model 15502 bus bar option

Full featured and field proven

Abet Technologies' model 15500 vacuum chuck facilitates testing of a wide variety of top-bottom contact solar. Its multizone design allows testing devices with sizes ranging from 3x3 mm to 50x50 mm.

Base sense probe, vacuum actuated, allows 4-wire metrology.

Top contact options include the Model 15502 set of socket mounted spring probes in one or more bus-bars or, the Model 15501 magnetic base option and one, or more, 15250 or 15251 Micromanipulators mounted Kelvin probes.

Temperature monitoring is always included.

A spectrum neutral metal mesh attenuator is included for Bowden method R_s value extraction.

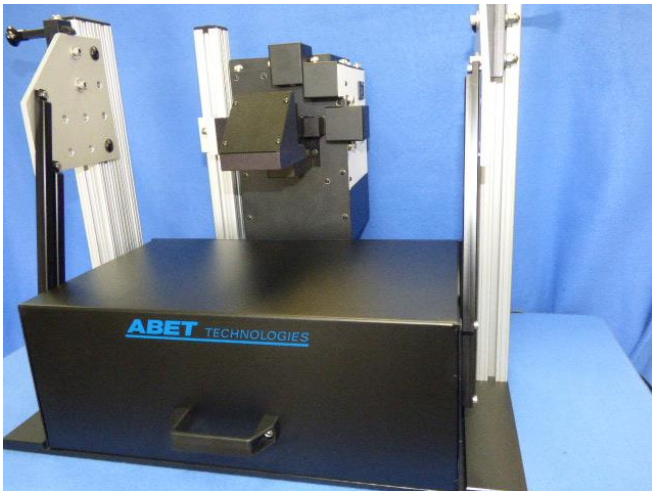

Abet Technologies Model 15504-1 dark enclosure with 11002 SunLite simulator PV IV setup

- Dual zone vacuum chuck for 3x3 mm to 50x50 mm cells
- Vacuum actuated sense probe
- 4-wire metrology standard
- Contact options:
 - Probe Bar
 - Micromanipulators
- Temperature monitored and temperature control ready
- Dark Enclosures options

Flexible and extendable capabilities

Each chuck includes a set of adjustable locators for reproducible cell metrology.

Thermally conductive, electrically insulating pads are available for top-top geometry cells.

Adding a heated recirculating chiller allows temperature-controlled operation. Maximum temperature is 70 °C. Ask for high temperature option if you plan to run tests beyond that level.

The 15504 Dark enclosure options allow dark curve acquisition.

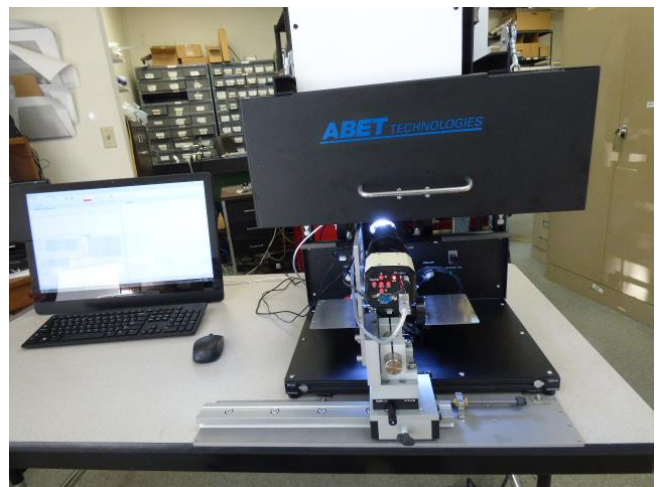

Abet Technologies Model 15504 dark enclosure with Sun 3000 simulator with slide mounted zoom camera probe alignment option

1550X Specifications

- 15500**
- Device size 3 – 50 mm
- Individual Vacuum zones 2
- Temperature monitored
- Temperature control ready
- Vacuum actuated base sense probe
- 15502**
- One Bus bars included
 - Gold-plated spring-loaded probes
 - Serrated ends standard, round ones available
 - Current probes 6
 - Isolated Sense probes 1
- 15501**
- Two side-mounted magnetic bases
- 15250**
- Precision micromanipulators
 - Kelvin probes standard
 - Extension mounts to allow full chuck surface access
- 15251**
- Low resolution micromanipulator – Kelvin probe standard

Abet Technologies regularly continues to upgrade our products, therefore all specifications are subject to change without notice.

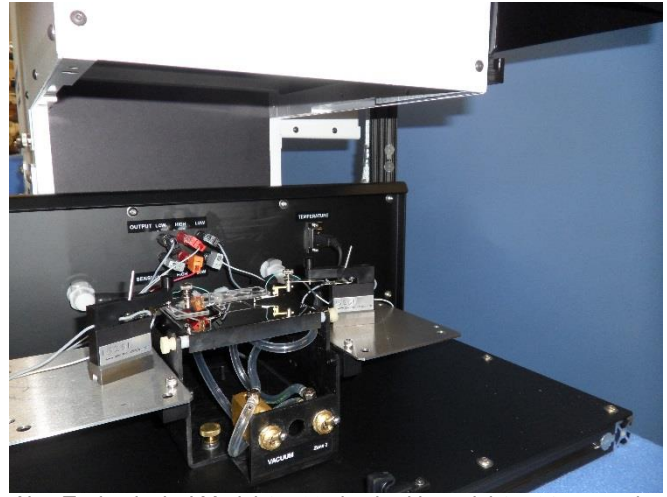

Abet Technologies' Model 15500 chuck with model 15501 magnetic base option and 15251 micromanipulators

Ordering Information

- 15500** 50x50 mm cells dual-zone vacuum chuck with calibrated temperature sensor, temperature control ready
 - 15501** Micromanipulator base option for 15500. Order micromanipulators and probes separately
 - 15502** Probe bar and actuator option for 15500. Includes one probe bar
 - 15503** Additional probe bar and mount for 15502
 - 15504** Dark enclosure for the 15500 and Sun 2000 or 3000
 - 15504-1** Dark enclosure for the 15500 and SunLite
 - 15250-R** Micromanipulator, precision, right handed
 - 15250-L** Micromanipulator, precision, left handed
 - 15251** Micromanipulator, low resolution. For 50x50 or smaller devices
 - IK1B10D1F** Kelvin probe with flat tip BeCu .38 mm dia contacts separated by 0.64 mm.
 - IK2B10D1F** Long mount Kelvin probe with flat tip BeCu .38 mm dia contacts separated by 0.64 mm
 - 15201-S** Replacement spring loaded pins (8), serrated end
 - 15285** Heating/cooling recirculator
 - 15447** Stand-alone microscope alignment slide assembly
 - 15275** Vacuum pump, 115 VAC. 21 LPM; 650 mm Hg max vacuum
 - 15276** Vacuum pump, 230 VAC. 17 LPM; 650 mm Hg max Vacuum
- Other Kelvin and single contact probes available. Please inquire.*



Abet Technologies' Model 15500 Stage with Model 15501 magnetic base and Model 15504 Dark enclosure in use with a Sun 3000 Solar Simulator

Abet Technologies offers an expanding line of ASTM, IEC and JIS standards compliant products for solar cell PV-IV testing, steady state solar simulators, test stations, software, calibrated reference cells and a selection of electronic loads for low and high current cells. Visit www.abet-technologies.com or contact us at sales@abet-technologies.com.

156x156 mm class Vacuum Chuck



Abet Technologies' Model 15510 chuck with model 15511 magnetic base option

Full featured and field proven

Abet Technologies' model 15510 vacuum chuck facilitates testing of a wide variety of top-bottom contact solar cells. Its multizone design allows testing devices with sizes ranging from 3x3 mm to 156x156 mm.

Base sense probe, vacuum actuated, allows 4-wire metrology.

Top contact options include the Model 15512 set of socket mounted spring probes in two or more bus-bars or, the Model 15511 magnetic base option and one, or more, 15250 or 15251 Micromanipulators mounted Kelvin probes. Switching between the bus-bar and micromanipulator contact options does not require any tools.

Temperature monitoring is always included.

A spectrum neutral metal mesh attenuator is included for Bowden method R_s value extraction.

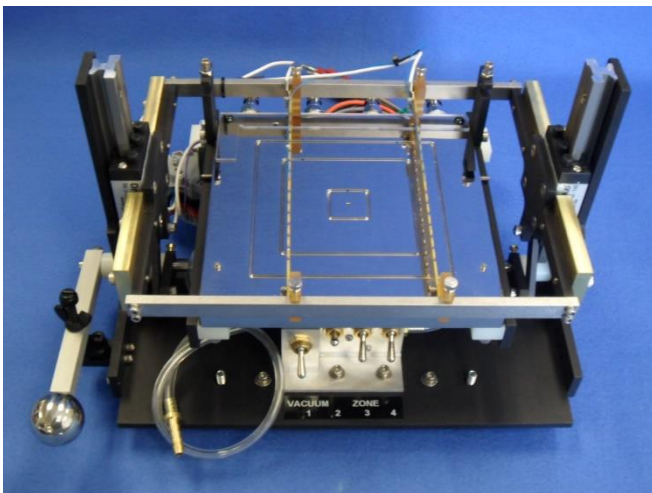

Abet Technologies' Model 15510 chuck with model 15512 bus-bars

- Multizone vacuum chuck for 3x3 mm to 156x156 mm cells
- Vacuum actuated sense probe
- 4-wire metrology standard
- Contact options: Probe Bars and Micromanipulators
- Temperature monitored and temperature control ready
- Optional Dark Enclosure
- Alignment microscopes available

Flexible and extendable capabilities

Each chuck includes a set of adjustable locators for reproducible cell metrology.

Thermally conductive, electrically insulating pads are available for top-top geometry cells.

Magnetic bases are mounted on sliders and articulated arms for full flexibility in micromanipulator positioning.

Adding a heated recirculating chiller allows temperature-controlled operation.

Including the rail option with the 15514 Dark enclosure lets the user align to small contact pads under a microscope.

1551X Chuck Specifications

15510

Device size 3 – 156 mm
Individual Vacuum zones 5
Temperature monitored
Temperature control ready
Vacuum actuated base sense probe

15512

Two Bus bars included
Gold-plated spring-loaded probes
Serrated ends standard, round ones available
Current probes 14
Isolated Sense probes 1

15511

Two articulated-arm slide mounted magnetic bases

15250

Precision micromanipulators
Kelvin probes standard
Extension mounts to allow full chuck surface access

Abet Technologies regularly continues to upgrade our products, therefore all specifications are subject to change without notice.

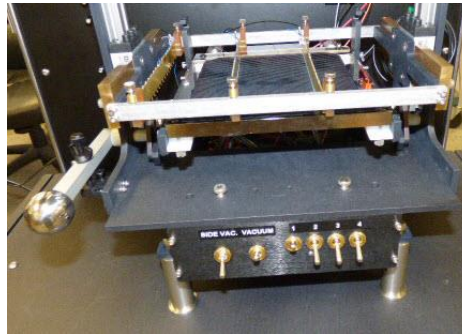

Abet Technologies' Model 15510 chuck with model 15512 bus bar

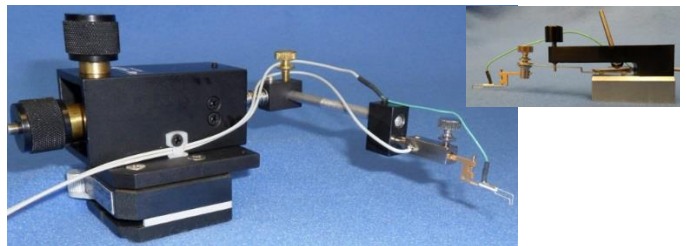

Abet Technologies 15250 and 15251 (insert) Micromanipulators



Abet Technologies' Model 15510 Stage with a large selection of its optional accessories in use with a Sun 3000 Solar Simulator

Ordering Information

- 15510** 156x156 mm cells multi-zone vacuum chuck with calibrated temperature interface, temp. control ready; special DSSC cell vacuum zone included
- 15511** Micromanipulator base option for 15510. Order micromanipulators and probes separately
- 15512** Probe bar and actuator option for 15510. Includes two probe bars
- 15513** Additional probe bar and mount for 15512
- 15514** Dark enclosure for the 1551x family of stations
- 15250-R** Micromanipulator, precision, right handed
- 15250-L** Micromanipulator, precision, left handed
- 15251** Micromanipulator, low resolution. For 50x50 or smaller devices
- IK1B10D1F** Kelvin probe with flat tip BeCu .38 mm dia contacts separated by 0.64 mm.
- IK2B10D1F** Long mount Kelvin probe with flat tip BeCu .38 mm dia contacts separated by 0.64 mm
- 15201-S** Replacement spring loaded pins (8), serrated end
- 15553** Stereo zoom probe alignment microscope, 3.5-45X, LED ring illuminator, USB camera, 2 Megapixels
- 15447** Stand-alone microscope alignment slide assembly

Other Kelvin and single contact probes available. Please inquire.

Abet Technologies offers an expanding line of ASTM, IEC and JIS standards compliant products for solar cell PV-IV testing, steady state solar simulators, test stations, software, calibrated reference cells and a selection of electronic loads for low and high current cells. Visit www.abet-technologies.com or contact us at sales@abet-technologies.com.

210x210 mm class Vacuum Chuck

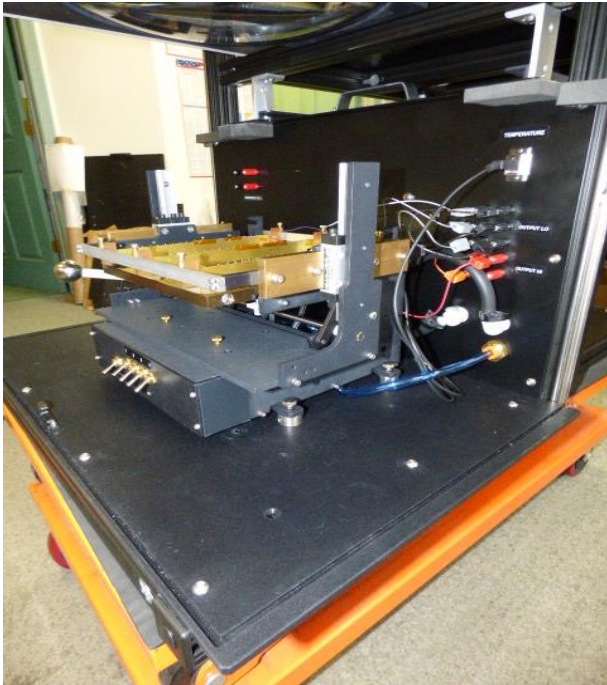

Abet Technologies' Model 15520 chuck with model 15522 bus-bars and 15524 dark enclosure

Full featured and field proven

Abet Technologies' model 15520 vacuum chuck facilitates testing of a wide variety of top-bottom contact solar cells. Its multizone design allows testing devices with sizes ranging from 3x3 mm to 210x210 mm.

Base sense probe, vacuum actuated, allows 4-wire metrology.

Top contact options include the Model 15522 set of socket mounted spring probes in two or more bus-bars or, the Model 15521 magnetic base option and one, or more, 15250 Micromanipulators mounted Kelvin probes.

Temperature monitoring is always included.

A spectrum neutral metal mesh attenuator is included for Bowden method R_s value extraction.

15524 Dark Enclosure option allows dark curve IV collection.

- Multizone vacuum chuck for 3x3 mm to 210x210 mm cells
- Vacuum actuated sense probe
- 4-wire metrology standard
- Contact options: Probe Bars and Micromanipulators
- Temperature monitored and temperature control ready
- Optional Dark Enclosure
- Alignment microscopes available

Flexible and extendable capabilities

Each chuck includes a set of adjustable locators for reproducible cell metrology.

Thermally conductive, electrically insulating pads are available for top-top geometry cells.

Adding a heated recirculating chiller allows temperature-controlled operation.

1552X Chuck Specifications

15520

Device size 3 – 210 mm
Individual Vacuum zones 5
Temperature monitored
Temperature control ready
Vacuum actuated base sense probe

15522

Two Bus bars included
Gold-plated spring-loaded probes
Serrated ends standard, round ones available
Current probes 18
Isolated Sense probes 1

15521

Two articulated-arm slide mounted magnetic bases

15250

Precision micromanipulators
Kelvin probes standard
Extension mounts to allow full chuck surface access

Abet Technologies regularly continues to upgrade our products, therefore all specifications are subject to change without notice.

300x300 mm class Vacuum Chuck

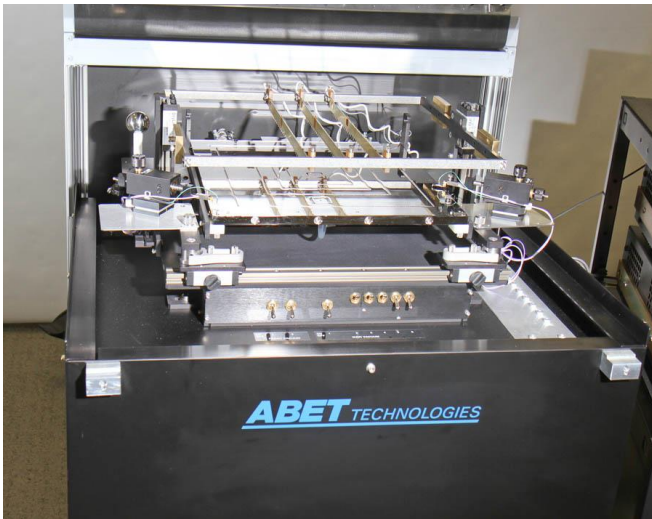

Abet Technologies' Model 15530 chuck with model 15531 magnetic base option, 15532 probe bar option, 15533 additional probe bar, and 15534 dark enclosure

Full featured and field proven

Abet Technologies' model 15530 vacuum chuck facilitates testing of a wide variety of top-bottom contact solar cells. Its multizone design allows testing devices with sizes ranging from 3x3 mm to 300x300 mm. An optional front located vacuum zone allows testing of small, 3-50 mm, devices using micromanipulator probes.

Base sense probe, vacuum actuated, allows 4-wire metrology.

Top contact options include the Model 15532 set of socket mounted spring probes in two or more bus-bars or, the Model 15531 magnetic base option and one, or more, 15250 Micromanipulators mounted Kelvin probes. Switching between the bus-bar and micromanipulator contact options does not require any tools.

Magnetic bases are mounted on sliders and articulated arms for full flexibility in micromanipulator positioning.

Temperature monitoring is always included.

A spectrum neutral metal mesh attenuator is included for Bowden method R_s value extraction.

Optional 15534 dark enclosure allows dark curve data collection.

- Multizone vacuum chuck for 3x3 mm to 300x300 mm cells
- Vacuum actuated sense probe
- 4-wire metrology standard
- Contact options: Probe Bars and Micromanipulators
- Temperature monitored and temperature control ready
- Optional Dark Enclosure
- Optional motorized chuck and probe bars
- Alignment microscopes available

Flexible and extendable capabilities

Each chuck includes a set of adjustable locators for reproducible cell metrology.

Thermally conductive, electrically insulating pads are available for top-top geometry cells.

Adding a heated recirculating chiller allows temperature-controlled operation.

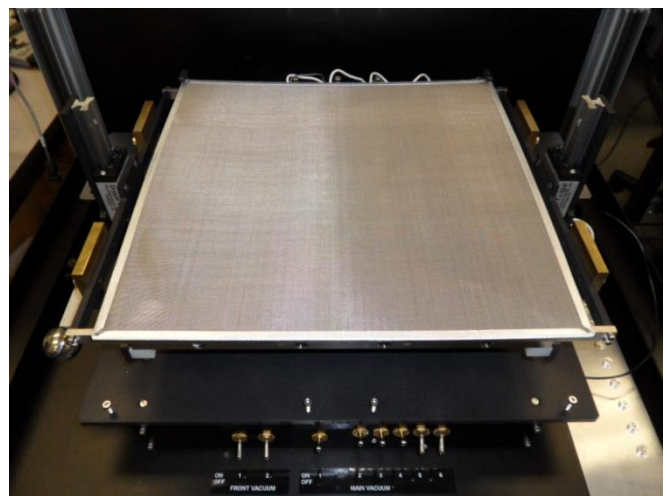

Spectrally neutral metal mesh attenuator for Bowden method R_s metrology

1553X Chuck Specifications

15530

Device size 3 – 300 mm
Individual Vacuum zones 6
Temperature monitored
Temperature control ready
Vacuum actuated base sense probe

15532

Two Bus bars included
Gold-plated spring-loaded probes
Serrated ends standard, round ones available
Current probes 28
Isolated Sense probes 1

15531

Two articulated-arm slide mounted magnetic bases

15250

Precision micromanipulators
Kelvin probes standard
Extension mounts to allow full chuck surface access

Abet Technologies regularly continues to upgrade our products, therefore all specifications are subject to change without notice.



Model 15530 300x300 mm stage with dark enclosure closed generating a dark IV curve using 15295 Universal load.



Model 15530SP 300x300 mm stage motorized chuck for CIGS mini-modules for automatic single cell and full mini-module IV metrology in use with a Sun 3000 Solar Simulator, a 15295 100V electronic load and four alignment microscopes. The simulator equipped with a filter wheel for Red and Blue and Attenuated measurements.

Ordering Information

- 15530** 300x300 mm cells multi-zone vacuum chuck with calibrated temperature interface, temp. control ready
- 15531** Micromanipulator base option for 15530. Order micromanipulators and probes separately
- 15532** Probe bar and actuator option for 15530. Includes two probe bars
- 15533** Additional probe bar and mount for 15532
- 15534** Dark enclosure for the 1553x family of stations
- 15250-R** Micromanipulator, precision, right handed
- 15250-L** Micromanipulator, precision, left handed
- IK1B10D1F** Kelvin probe with flat tip BeCu .38 mm dia contacts separated by 0.64 mm.
- IK2B10D1F** Long mount Kelvin probe with flat tip BeCu .38 mm dia contacts separated by 0.64 mm
- 15201-S** Replacement spring loaded pins (8), serrated end

Other Kelvin and single contact probes available. Please inquire.

Abet Technologies offers an expanding line of ASTM, IEC and JIS standards compliant products for solar cell PV-IV testing, steady state solar simulators, test stations, software, calibrated reference cells and a selection of electronic loads for low and high current cells. Visit www.abet-technologies.com or contact us at sales@abet-technologies.com.

PV IV Systems accessories

Micromanipulators

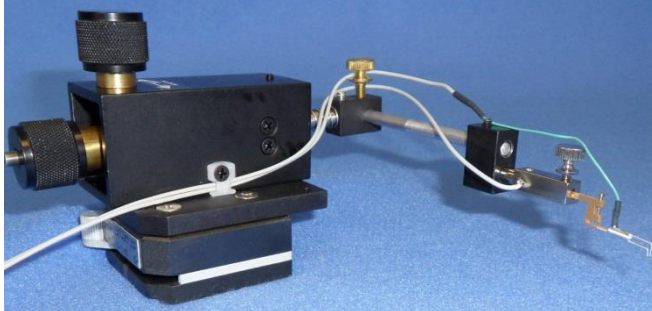

Abet Technologies 15250-L precision micromanipulator with an extender attached

Abet offers high and low resolution micromanipulators. Use the low resolution 15251 micromanipulator for contacting pads down to .5 mm. For higher resolution work use the precision 15250 micromanipulators. The right and left-handed 15250 micromanipulators are mounted on switchable magnetic bases and come with a set of extender rods to allow contacts on up to 300x300 mm stages. The extender kits also allow right angle probe mounting to further extend their positioning flexibility. Each micromanipulator is shipped with a Kelvin probe.

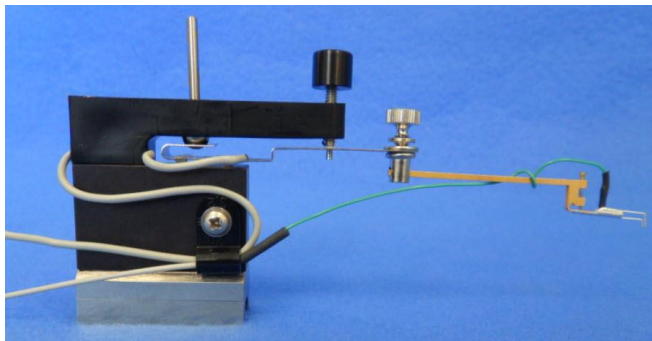

15251 Micromanipulator with a long mount Kelvin probe

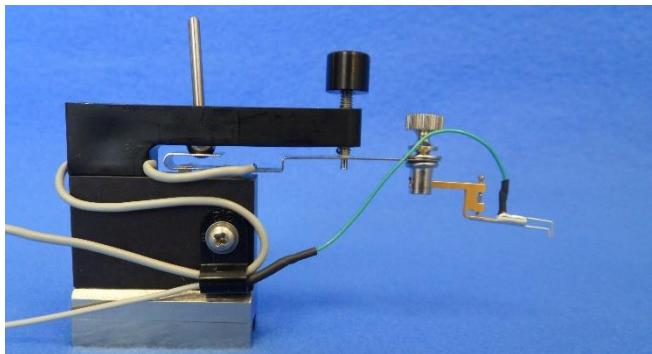

15251 Micromanipulator with a Kelvin probe

Heating/Cooling Recirculators

The 15285 Heating/Cooling Recirculator has a -20°C to 135°C range (please check the working fluid and chuck temperature limits which will typically be narrower). Other specifications are as follows: 0.1°C temperature resolution, 0.07°C temperature stability, 0.1 bar pressure, 10 l/min flow rate, 200W cooling capacity at 20°C, 1100 W heater, 7 l reservoir, and 54.1 x 22.1 x 64.5 cm dimensions.

Computer temperature control options are available for this and other similar recirculators.



Vacuum pumps



Approximately 20 l/min rated vacuum pumps are available in the line voltage and frequency of your country.

Alignment microscopes and cameras

Numerous choices of stereo zoom microscopes, microscope cameras and positioning slides allow construction of versatile test systems.

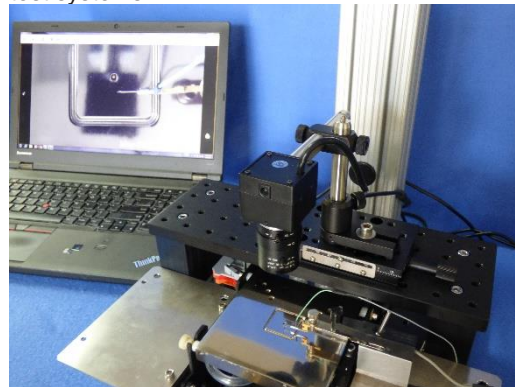

Ordering Information, PV IV Stations

Software

15000 Tracer™ PV IV Control and Measurement Software

Stations

- 15090** 156x156 Universal test platform
15500 50x50 mm cells multi-zone vacuum chuck with calibrated temperature interface, temp. control ready
15501 Micromanipulator base option for 15500. Order micromanipulators and probes separately
15502 Probe bar and actuator option for 15500. Includes one probe bar
15503 Additional probe bar and mount for 15502
15504 Dark enclosure for the 1550x family of stations
- 15510** 156x156 mm cells multi-zone vacuum chuck with calibrated temperature interface, temp. control ready; special DSSC cell vacuum zone included
15511 Micromanipulator base option for 15510. Order micromanipulators and probes separately
15512 Probe bar and actuator option for 15510. Includes two probe bars
15513 Additional probe bar and mount for 15512
15514 Dark enclosure for the 1551x family of stations
15515 DSSC bottom contact micromanipulator base option for 15510
- 15520** **210x210 mm** cells multi-zone vacuum chuck with calibrated temperature interface, temp. control ready
15521 Micromanipulator base option for 15520. Order micromanipulators and probes separately
15522 Probe bar and actuator option for 15520. Includes two probe bars
15523 Additional probe bar and mount for 15522
15524 Dark enclosure for the 1552x family of stations
- 15530** **300x300 mm** cells multi-zone vacuum chuck with calibrated temperature interface, temp. control ready; auxiliary front section for small cells metrology
15531 Micromanipulator base option for 15530. Order micromanipulators and probes separately
15532 Probe bar and actuator option for 15530. Includes two probe bars
15533 Additional probe bar and mount for 15532
15534 Dark enclosure for the 1553x family of stations

Special cells stations

- 15110** Station, Multiplexer Enabled, 12 devices, 2.54 pad spacing
15111 Station, flippable for microscope alignment, 100x100 mm, order micromanipulators separately
15114 25x25 mm DSSC test stage, 2.54 mm device spacing
15545 Back contact, three device cells test station, 25x25 mm

Micromanipulators and probes

- 15250-R** Micromanipulator, precision, right handed
15250-L Micromanipulator, precision, left handed
15251 Micromanipulator, low resolution. For 50x50 or smaller devices
IK1B10D1F Kelvin probe with flat tip BeCu .38 mm dia contacts separated by 0.64 mm.
IK2B10D1F Long mount Kelvin probe with flat tip BeCu .38 mm dia contacts separated by 0.64 mm

Other Kelvin and single contact probes available. Please inquire.

Ordering Information (cont'd)

Electronic loads

15295 Universal electronic loads with two Keysight High Speed DMMs and a **Kepeco Bipolar Amplifier**; please specify your max. current/voltage; add a third DMM if using a monitor cell.

Keithley SourceMeter™ or **Keysight Source Measure** unit - see page 29 for suggested models

778927-01 USB to GPIB adapter for Keithley 2400 series
15274 Stabilizing circuit for Keithley 2400 series

Temperature control/measurement

15285 Heating/cooling recirculator
15170 Calibrated temperature interface, USB

Accessories and spares

- 15552** Stereo zoom probe alignment microscope, 3.5-45X, LED ring illuminator
15553 Stereo zoom probe alignment microscope, 3.5-45X, LED ring illuminator, USB camera, 2 Megapixels
15447 Stand-alone microscope alignment slide assembly
- 15185** Monitor cell
- 15171** Bowden R_s determination method attenuator, 156x156
15172 Bowden R_s determination method attenuator, 200x200
15173 Bowden R_s determination method attenuator, 300x300
- 15275** Vacuum pump, 115 VAC. 20 LPM; 650 mm Hg max vacuum
15276 Vacuum pump, 230 VAC. 20 LPM; 650 mm Hg max vacuum
- 15277** Multiplexer, 64 1A capable relays (smaller relay count units available)
- 15201-S** Replacement spring loaded pins (8), serrated end

Solar Simulators

See Solar Simulator pages 6-19

Reference cells

See Reference cell pages 23-26

Abet Technologies regularly continues to upgrade our products, therefore all specifications are subject to change without notice.